

INSTRUCTIONS

Golden *Touch & Sew* 

Deluxe Zig-Zag Sewing Machine / Model 750

SINGER



The GOLDEN *Touch & Sew*

Deluxe Zig-Zag Sewing Machine by SINGER

Congratulations . . .

You are about to discover the wonderful pleasure of sewing with your new Golden *Touch & Sew* sewing machine. You will enjoy —

- the *simplicity* of dial controls. Now, you can simply dial a stitch length, a stitch width, and a stitch pattern; pressure and tension settings; even buttonhole stitching
- the *versatility* of sewing capacity that produces stitches that stretch, and stitches that *don't* stretch . . . permanent stitches that are firmly locked in, and temporary stitches that pull out easily . . . stitches that decorate, embroider, mend, baste
- and, of course, the *ease* of the push-button bobbin, the built-in needle threader, and much, much more!

Among the many Singer engineering and design features that ensure these sewing pleasures are —

- Both built-in and interchangeable *Fashion** Discs, which can produce an almost unlimited variety of practical and decorative stitch patterns
- *Flexi-Stitch** Discs that produce stretchable stitches for knits and other stretch fabrics as well as intricate stitch designs, including hem-stitching
- Soft-touch Fabric Feed that protects even the most delicate fabrics
- Variable-speed, Solid-state Control System that enables you to maintain the same pressure on the speed controller as you sew through varying fabric thicknesses
- One-way Needle Clamp that makes it impossible to put the needle in backwards
- Snap-on Presser Feet that are quickly removed and easily replaced
- Easy-to-change Throat Plates secured by magnets

As you go through this book, you will discover how these and many other features give you the ultimate in simplicity of operation and beautiful results.

Enjoy sewing!

CONTENTS

	Page
1. Getting to Know Your SINGER Sewing Machine	1
Principal Parts and What They Do	1
Accessories	2
2. Getting Ready to Sew	4
Preliminary Steps	4
Threading the Machine	5
Threading the Needle • Winding the Bobbin	
How to Start Sewing	8
Changing the Bobbin	9
3. Adjusting Machine to Your Fabric	11
Choosing Needle and Thread	11
Choosing Accessories	12
Adjusting Dials	16
4. Tips on Straight Stitching	18
Sewing a Seam	18
Pin Basting • Placing Fabric • Keeping Seams Straight • Turning Square Corners • Curved Seams • Reinforcing End of Seam	
5. All About Zig-Zag Stitching	21
How Patterns are Produced	21
Built-in Discs	21
<i>Fashion*</i> Discs	25
<i>Flexi-Stitch*</i> Discs	27
Combination Patterns	30
6. Twin-Needle Stitching	31
Preparation	31
Threading the Needle	31
Dial Settings	32
Turning a Square Corner	33
Decorative Twin-Needle Stitching	33
7. Temporary Stitching	34
Speed Basting	34
Chainstitching	36
8. Buttons and Buttonholes	41
Buttons	41
Buttonholes	42
Round-End Buttonholes	44
Bar-Tack Buttonholes	46
9. Free-Motion Stitching	47
Flower Embroidery	47
10. Sewing the Professional Way	48
Construction Details	48
Zippers • Darts • Inside Seam of Sheer Collars, etc. • Blindstitch Hems • Corded Seams • Seams in Fabrics that Ravel	
Sewing Knit and Stretch Fabric	54
Stretch Stitch Chart • Guiding and Supporting Fabric • Overedged Seams • Mock Over- edging • Finishes for Hems and Facings • Plain Stretch Seams • Lingerie Seams	
Decorative Touches	58
Hemstitching • Top Stitching • Picot Edges • Shell Edging • Scalloping • Applique • Monograms and Motifs • Fagoting • Patchwork Quilting • Drawn-Thread Work • Smocking	
Keeping Up Appearances	68
Mending • Darning • Blanket Binding • Growth and Shrinkage Tucks • Belt Carriers and Stay Chains	
11. Caring for Your Sewing Machine	73
Cleaning the Machine	73
Removal of Covers, Bobbin Case, and Bulb	75
Performance Checklist	78
12. Fashion* Aids	79
Index	82

1. GETTING TO KNOW YOUR MACHINE

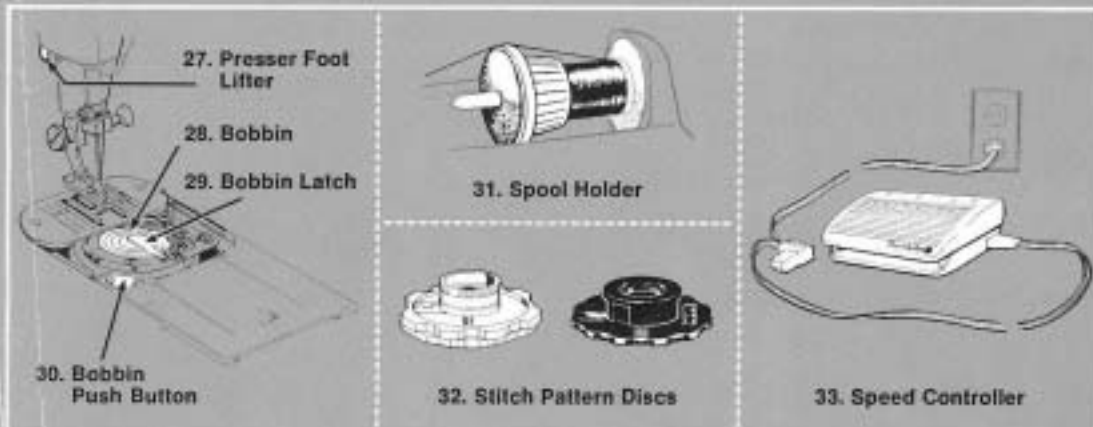
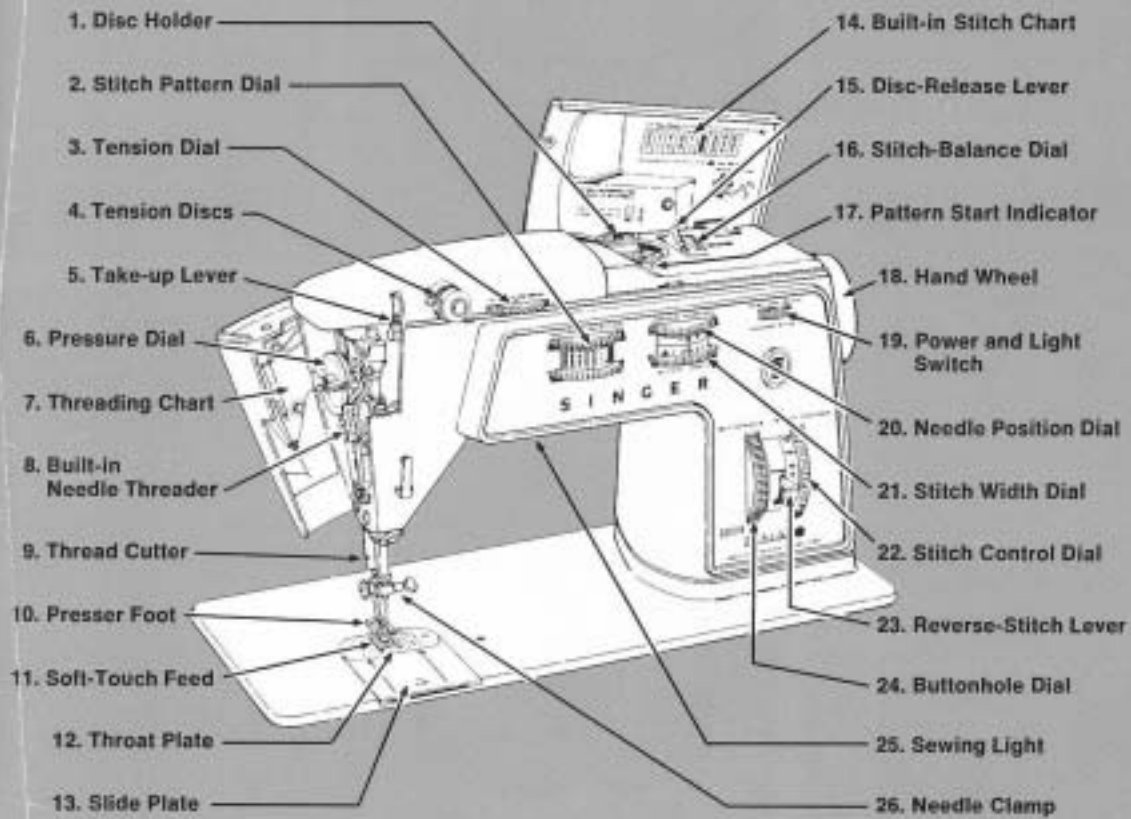

Principal Parts

Setting Ready to Sew

Adjusting Machine to Fabric

Straight Stitching

Zig-Zag stitching

Multi-Needle Stitching

Temporary stitching

Button Attachments

Free Motion stitching

Setting the Professional Way

Caring for Sewing Machine

Fashion Aids

principal parts and what they do

- 1. Disc Holder** holds any one of the interchangeable stitch pattern discs.
- 2. Stitch Pattern Dial** can be set to produce either a smooth straight stitch, a decorative or practical zig-zag stitch, or speed basting.
 - **To select a pattern**, push in dial and turn it to bring setting desired between red lines.
- 3. Tension Dial** lets you select just the right tension for your stitch, thread and fabric. The *MMMMMMMM* and *-----* symbols indicate approximate ranges for zig-zag and straight stitching. The numbers eliminate guesswork in duplicating settings.
 - **To increase tension**, turn dial to bring *higher* number under ▼ .
 - **To decrease tension**, turn dial to bring *lower* number under ▼ .
- 4. Tension Discs**, controlled by the tension dial, regulate the amount of tension on your needle thread.
- 5. Take-up Lever** controls flow of needle thread. Self-threading eyelet simplifies and speeds threading of machine.
- 6. Pressure Dial** regulates presser-foot pressure on fabric. It has an all-purpose setting plus settings for extra-light and extra-heavy pressure and for darning.
 - **To increase pressure**, lower presser foot and turn dial from **NORM** toward **MAX**.
 - **To decrease pressure**, lower presser foot and turn dial from **NORM** toward **DARN**.
 - **For darning**, lower presser foot and set dial on **DARN**.
- 7. Threading Chart** on swing-open face plate is convenient, easy to read.
- 8. Built-in Needle Threader** allows you to thread the needle easily and conveniently.
 - **To use**, raise needle and lower the needle threader. Position threader behind needle and draw it toward you so that the hook guides straddle the needle and the threading hook enters eye of needle. Place thread across hook and draw thread through eye of needle.
- 9. Thread Cutter** is built into presser bar for safety and convenience.
- 10. Presser Foot** holds fabric against feed. The most commonly used feet snap off for quick removal.
- 11. Soft-Touch Feed** moves fabric under presser foot. Soft surface does not injure fabric, even the most delicate.
- 12. Throat Plate** lifts out for easy removal. Guidelines on right and left sides help you keep seams straight.
- 13. Slide Plate** opens easily, lets you see bobbin. Releases bobbin push button from winding to sewing position when closed. Seam guidelines (extended from throat plate) have cross lines to help you turn square corners.
- 14. Built-in Stitch Chart** is easy to read, allows for quick selection of a variety of stitches. It can be left open while you sew.
- 15. Disc-Release Lever** allows for interchange of stitch pattern discs.
 - **To change disc**, push lever back.
- 16. Stitch-Balance Dial** varies the forward-reverse balance of *Flexi-Stitch* patterns.
 - **To adjust balance**, turn dial forward (toward you) or backward (away from you) until the desired balance is obtained.
- 17. Pattern Start Indicator** lets you start stitching at the beginning of a stitch pattern unit.

- 18. Hand Wheel** controls movement of take-up lever and needle. Always turn it toward you.
- 19. Power and Light Switch** turns on machine and sewing light simultaneously. **FAST** and **SLOW** speed range settings let you choose the best sewing speed for your work.
- 20. Needle Position Dial** places needle in either **L** (left), **A** (center) or **R** (right) stitching position and has a special **MIX** setting for combination stitch patterns.
- **To set needle position**, turn dial to bring setting desired under red line.
- 21. Stitch Width Dial** controls the width of zig-zag stitching and positions the needle for bobbin winding and straight stitching.
- **To set stitch width**, turn dial to bring setting desired under red line. Use **A** for straight stitching and bobbin winding.
- 22. Stitch Control Dial** allows for a variety of stitch lengths, including **FINE** for zig-zag satin stitching. Has special settings for buttonholing, *Flexi-Stitch* disc patterns, and speed basting.
- **To set**, turn dial until setting desired is under the red line.
- 23. Reverse-Stitch Lever** instantly reverses stitching direction at the touch of your finger.
- **To reverse stitching**, press lever all the way down and hold in place. Release lever for forward stitching.
- 24. Buttonhole Dial**, with two simple settings, controls steps in sewing round-end buttonholes. *Dial must be in OFF position when not in use.*
- **To set**, turn dial downward until buttonhole symbol for Step 1 or Step 2 is under the red line.
- 25. Built-in Sewing Light** illuminates sewing area. Pull-down bracket makes it easy to replace bulb.
- 26. Needle Clamp** holds single and twin needles. It is designed to make needles self-setting and eliminate the possibility of inserting needle backwards.
- 27. Presser Foot Lifter**, at back of machine, allows you to raise and lower presser foot. Extra-high lift position permits easy placement of bulky fabrics.
- 28. Transparent Bobbin** shows thread supply. Two halves can be unscrewed to remove unwanted thread.
- 29. Bobbin Latch** holds bobbin in place. Flips up at the touch of your finger for easy bobbin removal.
- 30. Bobbin Push Button** allows you to switch from sewing to bobbin winding without removing bobbin.
- 31. Friction-Free Spool Holder** with horizontal pin holds spools of various sizes; holder lets thread unwind without tug or drag. The spool does not turn.
- 32. Interchangeable Stitch Pattern Discs** enlarge the scope of decorative applications as well as serving such practical purposes as sewing on stretch fabrics. Each disc is numbered and its design is reproduced on its surface for quick recognition.
- **To change discs**, turn dials away from **A** and **MIX** settings, and press disc-release lever.
- 33. Electrical Connections and Speed Controller**, designed for convenience and safety, actuate the solid-state speed control system.
- **To run the machine and control speed**, press the speed controller. The harder you press, the faster the machine will sew within the speed range you select.
 - **To stop the machine from sewing**, remove pressure from the speed controller.

Principle
Parts

Getting Ready
to Sew

Adjusting
Machine
to Fabric

Straight
Stitching

Zig-Zag
Stitching

Twin-Needle
Stitching

Temporary
Stitching

Buttons
Buttonholes

Free Motion
Stitching

Sewing the
Professional
Way

Caring for
Sewing
Machines

Fashion
Aids

accessories

The accessories that come with your Golden Touch & Sew sewing machine are designed to help you do many kinds of sewing easily and perfectly.

To increase the versatility of your sewing machine still further, additional accessories can be purchased at your Singer store. For descriptions, see pages 79 to 81.

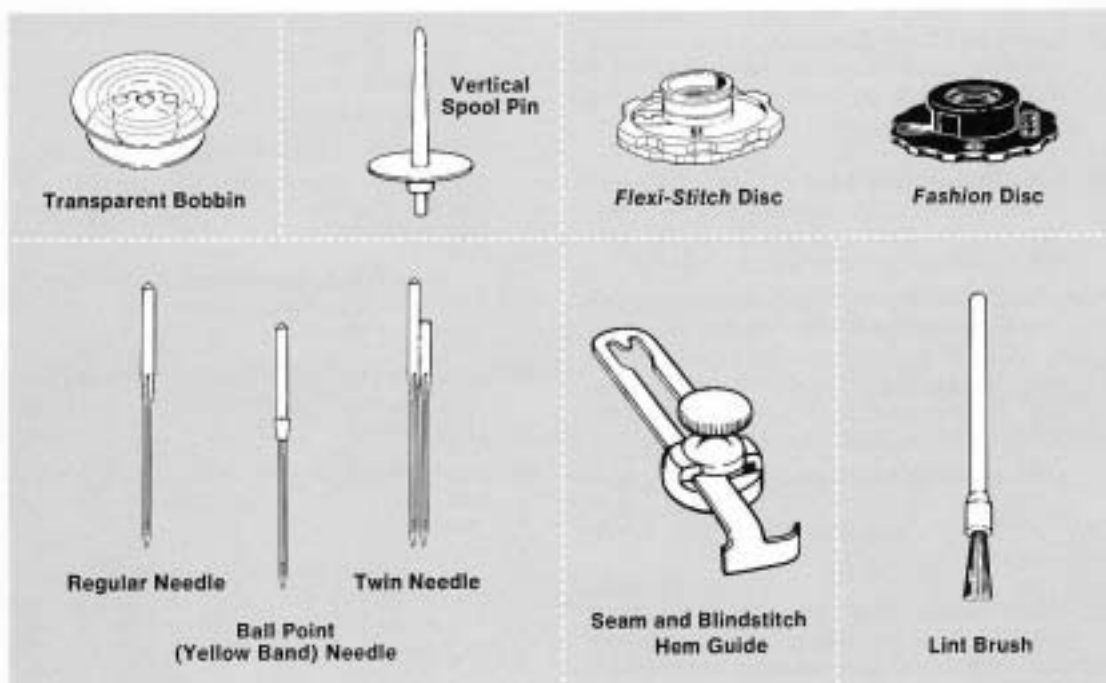

1. BOBBINS

- One transparent drop-in bobbin in your machine.
- Six extra transparent drop-in bobbins.

2. VERTICAL SPOOL PIN

- One vertical spool pin for decorative twin-needle stitching.

3. NEEDLES

- Catalog 2020 (15x1) needle in machine.

With your accessories —

- Catalog 2020 (15x1) needles, for all-purpose sewing.
- Catalog 2045 ball-point (yellow band) needles, for sewing synthetic knits and stretch fabrics.

- Catalog 2028 needle, for twin-needle decorative stitching.

4. STITCH PATTERN DISCS

- One light-colored *Flexi-Stitch* Disc in place on holder in machine.
- Eight additional light-colored *Flexi-Stitch* Discs.
- Eight black *Fashion* Discs.

5. SEAM AND BLINDSTITCH HEM GUIDE

- One guide to help you stitch seams and blindstitch hems of uniform width.

6. LINT BRUSH

- One lint brush for cleaning your sewing machine.

7. PRESSER FEET

- The general purpose foot on your machine.
- Three additional interchangeable snap-on presser feet:

Straight stitch foot for close fabric control

Buttonhole foot to make round-end buttonholes

Overedge foot for overedged seams in stretch fabric

- Three one-piece presser feet:

Zipper foot for inserting zippers and stitching corded seams

Special purpose foot for all kinds of decorative zig-zag stitching.

Button foot to hold buttons securely for stitching

8. THROAT PLATES

- The general purpose throat plate in place on machine.
- The straight stitch throat plate (for use with the straight stitch foot).
- The chainstitch throat plate (for single-thread chainstitching).
- The feed-cover throat plate (for button sewing and free-motion work).

9. CHAINSTITCH FITTINGS

- One set of three fittings:
 - Bobbin case cover
 - Throat plate (listed above)
 - Thread guide

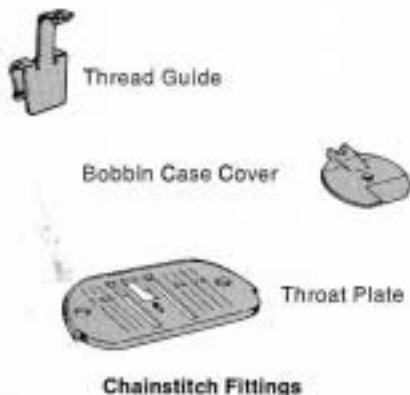

Presser Feet

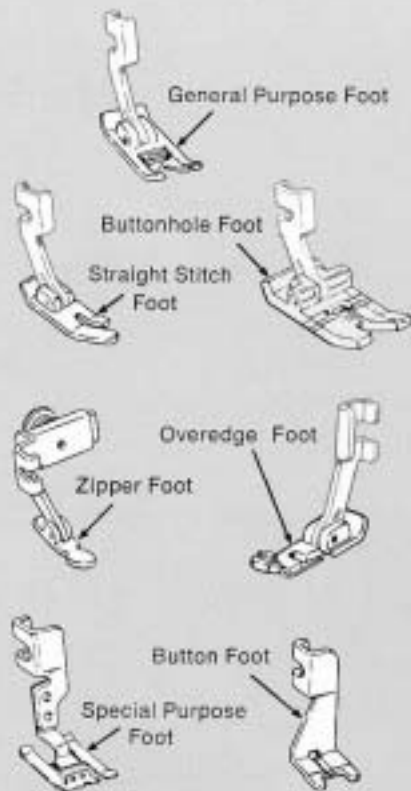

Throat Plates

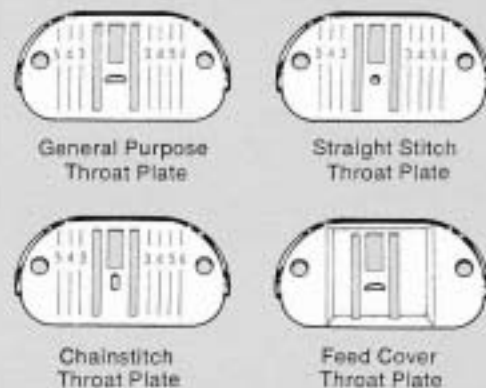

2. GETTING READY TO SEW

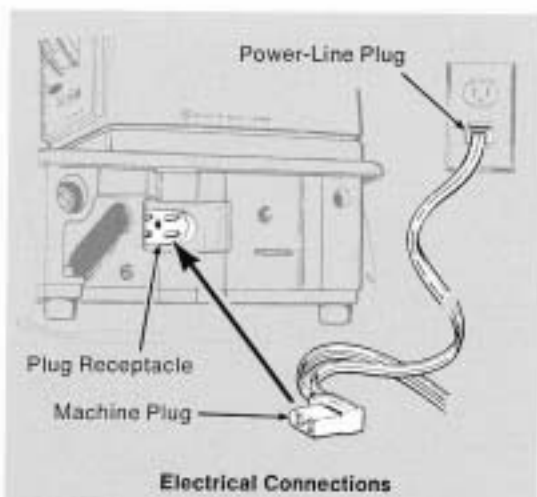

preliminary steps

1. CONNECTING MACHINE

Before plugging in your machine, be sure that the voltage and number of cycles indicated at the right end of the machine, or on top surface of face plate, conform to your electrical power supply.

Push the machine plug into the machine receptacle. Then connect the power-line plug to your electrical outlet.

2. OPERATING MACHINE AND CONTROLLER

To turn on both the machine and sewing light and set speed range, slide the power and light switch to the selected range.

- The **FAST** setting allows for full speed capacity of the machine. It is best for long, straight seams, easy-to-handle fabrics, and general sewing where a variety of speeds are needed.
- The **SLOW** setting allows for maximum control at lower sewing speeds. Use this setting for special jobs such as button sewing, buttonhole making, and where intricate construction details require close control.

CAUTION: We recommend that you turn off the power and light switch before changing needles, presser feet or throat plates and when leaving the machine unattended. This eliminates the possibility of starting the machine by accidentally pressing the speed controller.

To run the machine, press the speed controller (or knee lever). The harder you press, the faster the machine will sew within the selected speed range.

Very light pressure on the controller (or knee lever) will operate the machine very slowly, enabling you to stop the machine with the needle in any desired position, up or down.

threading the machine

Spools of various sizes are held firmly on the horizontal spool pin with the spool holder. Slip spool of thread onto spool pin and press holder firmly against spool so that thread unwinds from a stationary spool.

To hold small spools — press *small* end of holder against spool.

To hold large spools — press *wide* end of holder against spool.



To hold small spools



To hold large spools



With two hands, slip thread horizontally *between* tension discs from the top.



With right hand, lead thread *under* thread guide on right side . . .



. . . and, with left hand, lead thread *over* spring and *under* guide on left side.



Allow spring to return to its normal up position and continue threading the machine.

THREADING THE NEEDLE

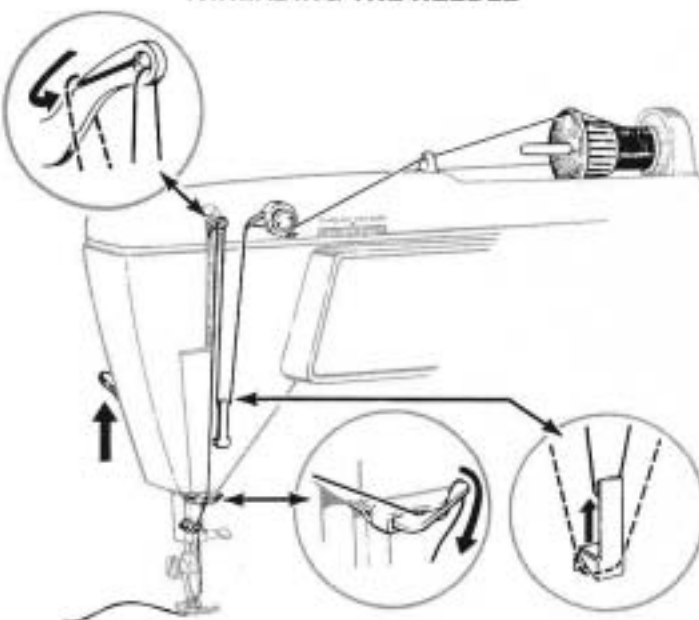

1. Turn hand wheel to raise take-up lever to its highest position, and *raise presser foot* to release the tension discs.
2. Lead thread through all points as shown, making sure to:
 - Thread tension discs as illustrated.
 - Thread take-up lever from *back* to *front*, guiding thread down over top of lever and then up into eyelet.
 - Thread needle from *front* to *back*, drawing about four inches of thread through eye of needle.

For greater convenience in threading the needle, use the built-in needle threader (see next page for instructions).

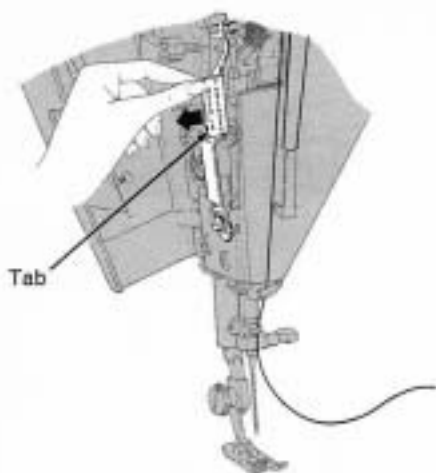

Needle Threader in Storage Position

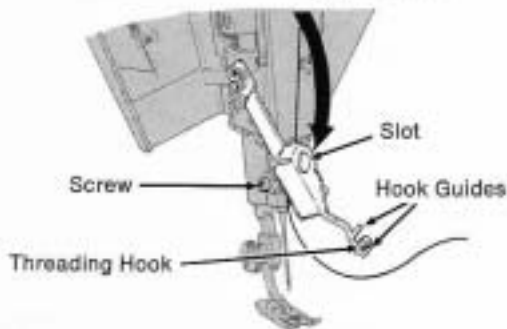

Lowering Needle Threader

Threading Needle with Built-in Threader

1. Draw approximately five inches of thread through threading points of machine. Be sure to thread the guide above the needle. Then lower the presser bar and raise the needle to its highest position.
2. Open face plate and lower the threader from its storage position by gently pulling the arm out to the left and swinging it down in line with the needle.
3. Position slot in threader arm over screw on needle clamp, bringing threader hook and guides behind the needle.
4. Pull tab toward you so that the upper and lower hook guides straddle the needle (one on either side) and the threading hook comes through the eye of the needle.
5. Place thread across the threading hook, keeping two or three inches of slack thread to the right of the hook and one to two inches to the left. Withdraw hook from needle eye by pushing threader arm gently back and to the left.
6. Release thread from hook *carefully* and return threader to its storage position. Close face plate and raise presser foot.

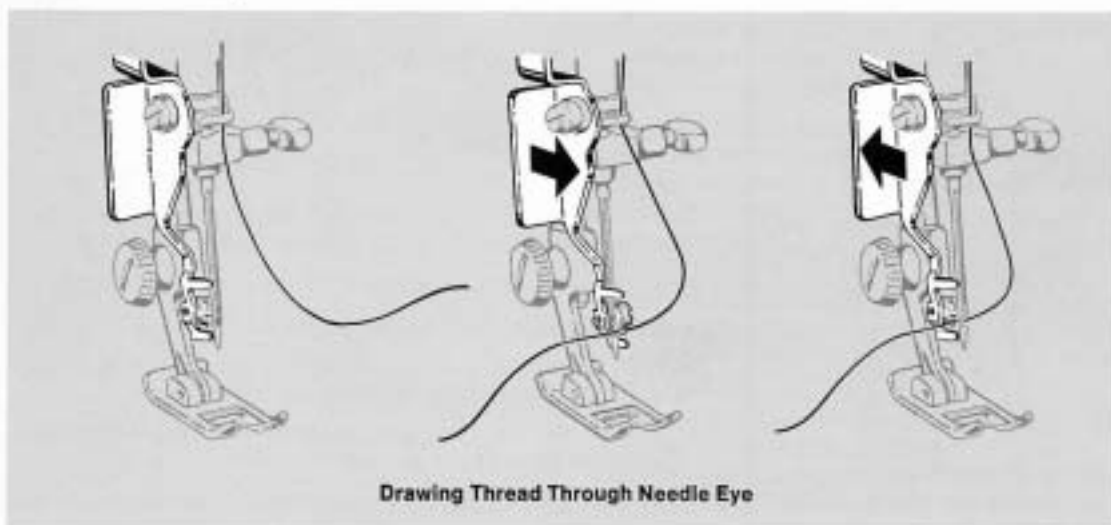

Drawing Thread Through Needle Eye

WINDING THE BOBBIN

The push-button bobbin will make your sewing go faster than ever before — whether you are using a lot of one kind of thread or small quantities of different threads, as you are likely to do when mending or darning.

You will find a bobbin in place under the slide plate of your machine. (To open slide plate, simply slide it gently toward you.) If the bobbin runs out of thread while you are sewing, you can rewind it without removing it from the machine.

Preparation Steps

Make sure buttonhole dial is in **OFF** position.

1. Use general purpose, special purpose, or straight stitch presser foot.
2. Raise presser foot to release tension on thread, and raise the needle to its highest position. (Make sure your needle is larger than a size 9. See footnote on page 11.)
3. Open slide plate and make sure bobbin is empty. For removal of bobbin and thread, see page 9.
4. Set needle position and stitch width dials at straight stitch setting indicated by ▲ symbols.

Winding Steps

1. Press bobbin push button to the left to engage it in winding position.
2. Wrap thread around presser foot screw, and hold end of thread firmly.
3. Start the machine.
 - Run the machine at a moderate speed.
 - Pull thread end away after a few coils have been wound.
 - Keep your eye on the bobbin as it fills. *Do not allow thread to wind beyond the outside FULL ring.*
4. Close slide plate to release push button to sewing position. Turn to the next page for instructions on starting to sew.



Bobbin

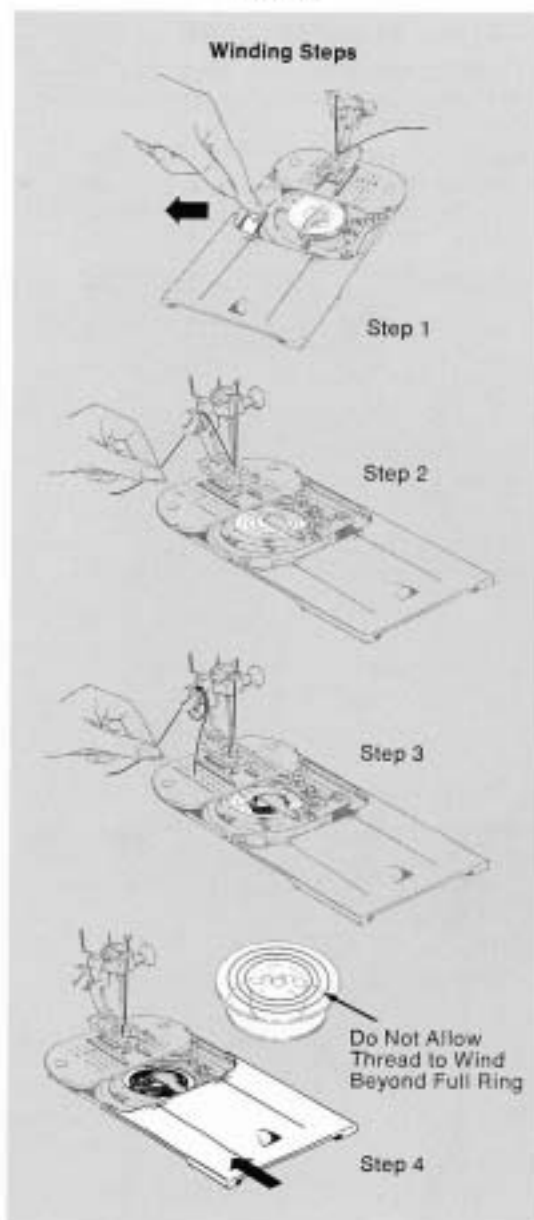

how to start sewing

How you begin to sew after winding a bobbin depends on whether your stitching is to start at or away from the edge of the fabric.

TO START AT FABRIC EDGE

- Position needle in very edge of fabric by pressing speed controller lightly or turning the hand wheel.
- Lower the presser foot and stitch. The continuous thread, leading from the needle to the bobbin, will "lock" over the fabric edge.

TO START AWAY FROM FABRIC EDGE

- Pull thread back under presser foot and cut.
- Position needle in fabric where desired and stitch.

NOTE: Should the bobbin run out of thread after you have begun a line of stitching, remove the fabric, rewind the bobbin, and follow the two immediately preceding steps.

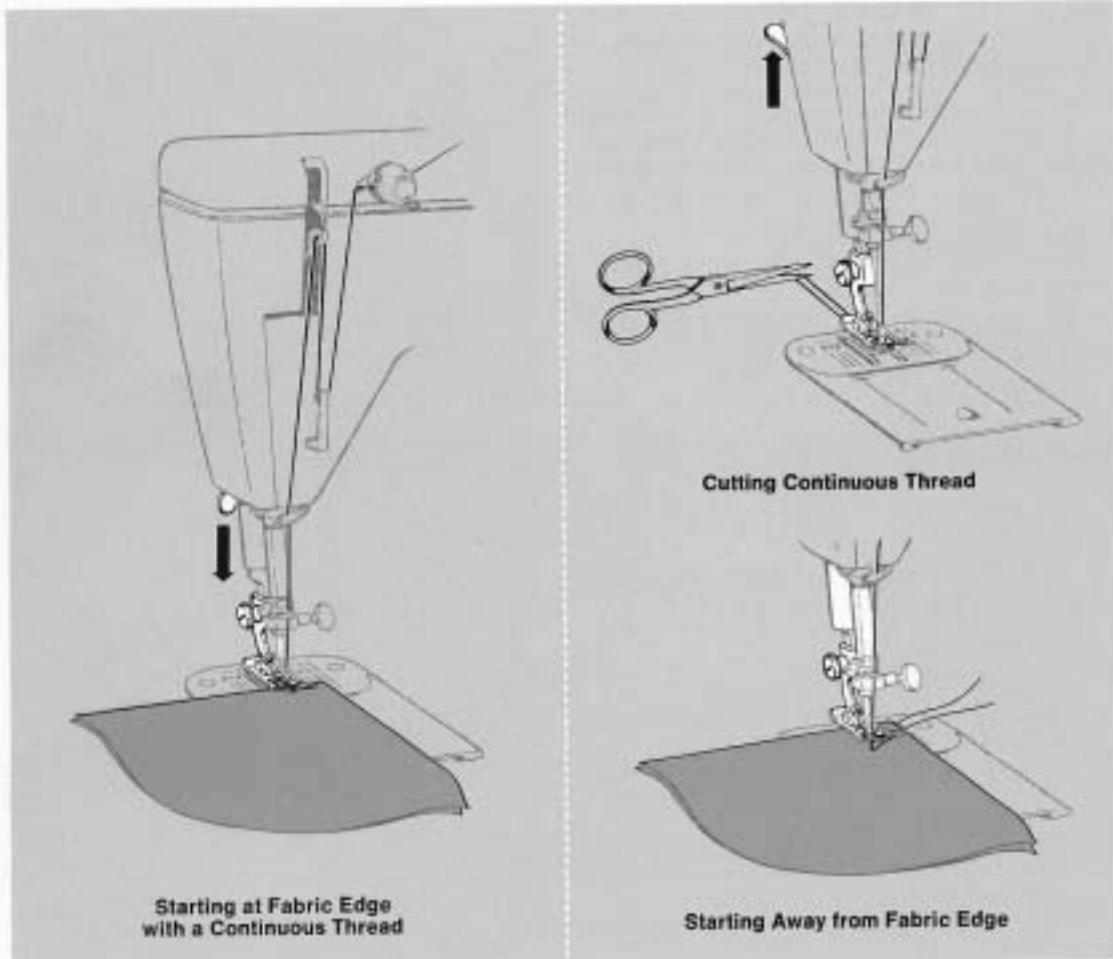

changing the bobbin

REMOVING THE BOBBIN

Raise needle to its highest position.

1. Open slide plate; leave bobbin push button in sewing position.
2. Raise bobbin latch by inserting fingernail under end of latch at center of bobbin.
3. Insert fingernail under rim of bobbin immediately to right of latch and remove the bobbin.

REPLACING AN EMPTY BOBBIN

1. Make sure bobbin halves are securely tightened.
2. With latch raised, slip bobbin (wide side up) into bobbin case. Then snap latch down to secure bobbin.
3. Leave the slide plate open until you have finished winding.

REMOVING THREAD FROM BOBBIN

If there is not much thread left on the bobbin, you do not need to remove bobbin from machine — simply pull the thread end through the throat plate.

If there is a lot of thread left and you do not wish to reserve it by setting aside the bobbin for future use, remove the bobbin, unscrew the two halves, and remove all the thread at once.

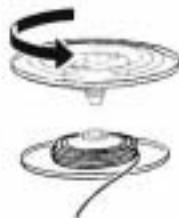

Removing Thread from Bobbin

Removing Bobbin

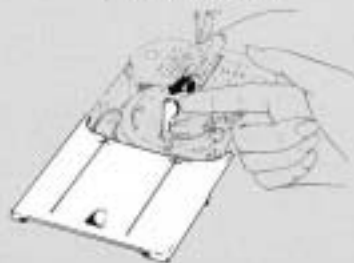

Open Slide Plate and Raise Latch



Lift Out Bobbin

Replacing Empty Bobbin

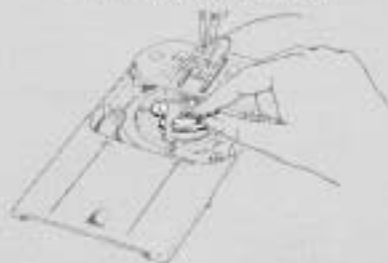

Slip Bobbin into Case



Snap Latch Down

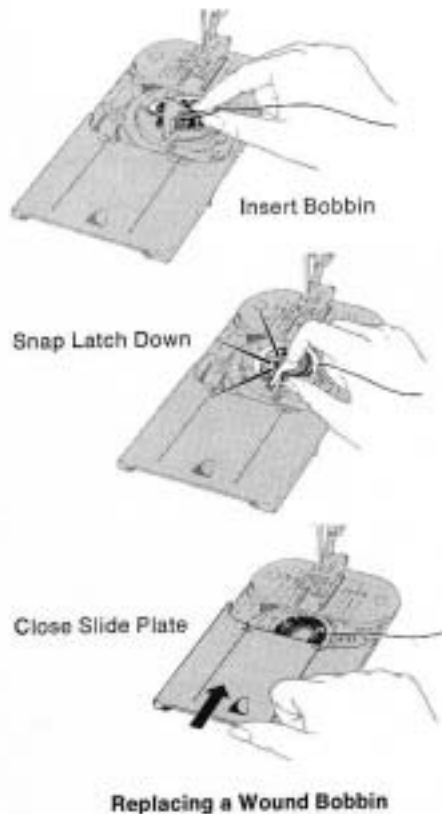

REPLACING A WOUND BOBBIN

Raise needle to its highest position.

1. Open slide plate; leave bobbin push button in sewing position.
2. Draw three or four inches of thread from bobbin and place bobbin in case with thread leading off to right side of latch. Snap latch down to secure bobbin.
3. Close slide plate, allowing the thread to enter the slot in the slide plate. Then raise the bobbin thread.

RAISING THE BOBBIN THREAD

1. Hold needle thread lightly with left hand and turn hand wheel slowly toward you so that needle enters throat plate.
2. Continue turning hand wheel until needle rises and brings up bobbin thread in a loop.
3. Undo the loop and place both threads under the presser foot, laying them diagonally to the right. Position needle in fabric where desired, lower the presser foot and stitch.

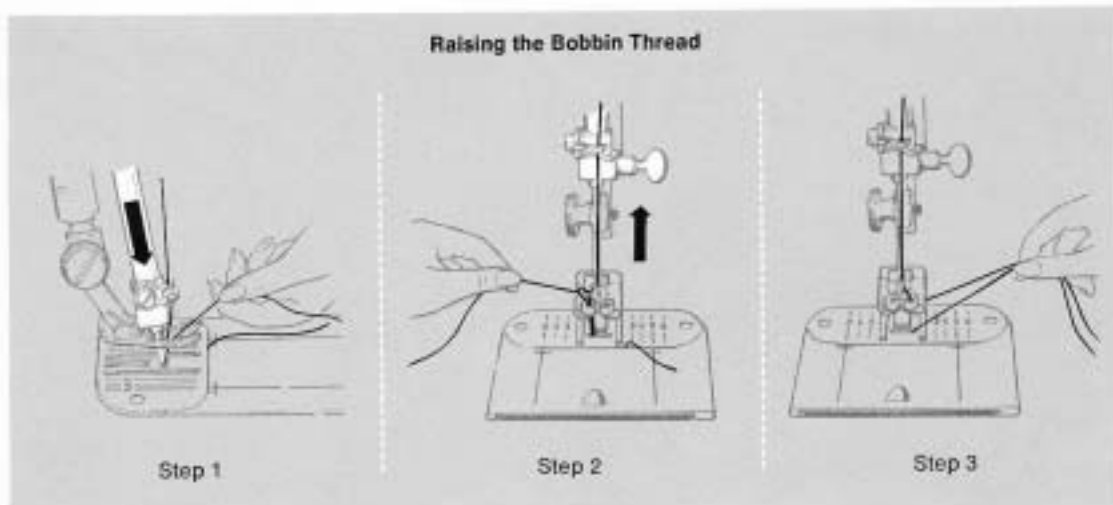

3. ADJUSTING MACHINE TO YOUR FABRIC

choosing needle and thread

The needle and thread you choose will depend upon the fabric being stitched. The table below is a practical guide to needle and thread

selection. Refer to it before starting a sewing project. Be sure to use the same size and type of thread in both needle and bobbin.

FABRIC, THREAD AND NEEDLE TABLE†

FABRIC	THREAD	NEEDLES	
		TYPE	SIZE
DELICATE — tulle, chiffon, fine lace, organza	Fine mercerized cotton Fine synthetic thread	CATALOG 2020 (15x1)	9††
LIGHTWEIGHT — batiste, organdy, jersey, voile, taffeta, crepe, chiffon velvet, plastic film	50 mercerized cotton "A" silk Synthetic thread Polyester core/cotton	CATALOG 2020 (15x1)	11
MEDIUM WEIGHT — gingham, percale, pique, linen, chintz, faille, satin, fine corduroy, velvet, suitings, knits, deep-pile fabrics, vinyl	50 mercerized cotton 60 cotton "A" silk Synthetic thread Polyester core/cotton	CATALOG 2020 (15x1)	14
MEDIUM HEAVY — gabardine, tweed, sailcloth, denim, coatings, drapery fabrics, vinyl, deep-pile fabrics	Heavy-duty mercerized cotton 40 to 60 cotton Synthetic thread	CATALOG 2020 (15x1)	16
HEAVY — overcoatings, dungaree, upholstery fabrics, canvas	Heavy-duty mercerized cotton 24 to 40 cotton Synthetic thread	CATALOG 2020 (15x1)	18
ALL WEIGHTS — decorative top stitching	"D" silk††† (Buttonhole twist)	CATALOG 2020 (15x1)	18
ALL WEIGHTS — decorative hemstitching	50 mercerized cotton "A" silk Synthetic thread	CATALOG 2020 (15x1)	18
SYNTHETIC KNITS AND STRETCH FABRICS — polyester doubleknit, nylon tricot, jersey, spandex, cire tricot, panne velvet	"A" nylon 50 mercerized cotton "A" silk Polyester core/cotton	CATALOG 2045 Ball Point (Yellow Band)	14
LEATHER — suede, kidskin, capeskin, lambskin, lined leathers	50 mercerized cotton Synthetic thread "A" silk Polyester core/cotton	CATALOG 2032 (15x2)	11 14 16
LIGHT AND MEDIUM WEIGHTS — decorative twin-needle stitching	50 mercerized cotton	CATALOG 2028 (twin)	14

†Does not apply to chainstitching.

††Size 9 needle recommended for sewing only. For bobbin winding use larger size needle.

†††Use with 50 mercerized cotton or "A" silk in bobbin.

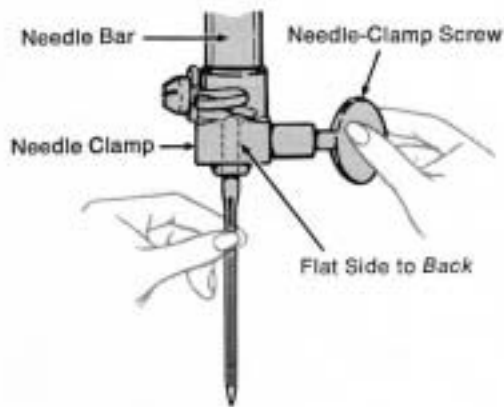

Changing the Needle

NEEDLES

The needle you use should be straight to ensure perfect stitch formation and needle penetration through the fabric. The needle should also be fine enough to prevent the fabric from being marred with large punctures, yet heavy enough to pierce the fabric without being bent or deflected. Remember, too, that the eye of the needle must be large enough for the thread to pass through freely; too fine a needle will cause the thread to fray.

Changing the Needle

1. Raise needle bar to its highest point, loosen needle-clamp screw, and remove needle.
2. Insert new needle in clamp, *with the flat side of the needle to the back*; push it up as far as it will go.
3. Tighten needle-clamp screw.

choosing accessories

The type of sewing you plan to do will determine which presser foot and throat plate you should use.

PRESSER FEET

Three Most Used Presser Feet

General purpose foot is used with the general purpose throat plate for all utility sewing and some decorative zig-zag stitching. These general purpose accessories *must* be used together when alternating between straight and zig-zag stitching.



General Purpose Foot

Straight stitch foot is used with the straight stitch throat plate when your fabric or sewing procedure requires close control. Use for:

- Precision stitching of curved and scalloped edges, top stitching, edge stitching, etc.
- Stitching delicate or spongy fabrics.

Special purpose foot is used with the general purpose throat plate for all kinds of decorative zig-zag stitching. The raised center section of the foot allows closely spaced zig-zag stitching to feed freely while the toe holds fabric firmly for straight line feeding. The holes in the front of the foot hold a filler cord when that is desired. Use for:

- Ornamental stitching, bar-tack buttonholes, *Flexi-Stitch* pattern stitching, applique, satin stitching.

Presser Feet for Special Sewing Needs

Zipper foot is used to place stitching close to a raised edge. Thus, it is useful for corded seams (page 52) as well as zipper insertion (page 48). It can be adjusted to either the left or right side of the needle.

Button foot holds any two-hole or four-hole button securely for stitching. The groove in the foot can be used to hold a needle, over which a thread shank can be formed.

Buttonhole foot. This snap-on transparent foot is used to make two-step, round-end buttonholes in fabrics of light to medium weight. The guidelines on the sole plate simplify buttonhole placement and make it easy to gauge buttonhole length.

Overedge foot, used with *Flexi-Stitch* Disc 59, enables you to produce flexible overedged seams and edge finishes. It is particularly useful in construction of garments made of knit, stretch, and elastic fabric.

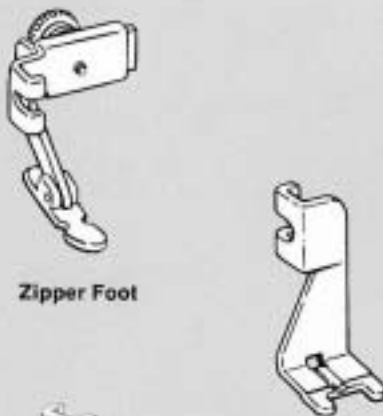

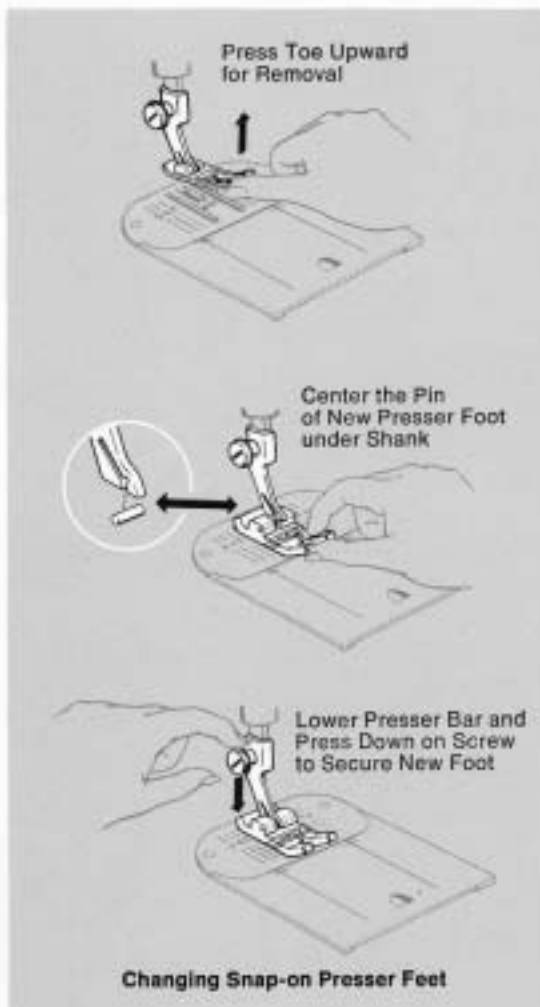

CHANGING PRESSER FEET

Snap-on Presser Feet

These presser feet snap on and off a common shank.

1. Raise needle to its highest position and raise the presser foot.
2. Press toe of presser foot upward (as far as it will go) and then snap down to remove.
3. Center the new presser foot under the shank and lower the presser bar so that the shank fits over the presser foot pin.
4. Press down on presser foot screw until foot snaps into place.

To remove and replace shank of snap-on presser feet, follow instructions below for one-piece presser feet.

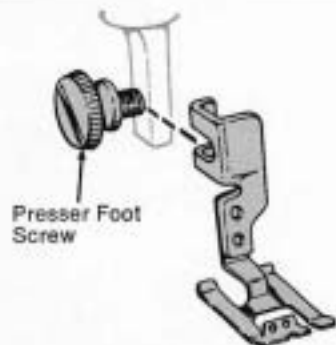

Changing One-Piece Presser Foot

One-Piece Presser Feet

1. Raise needle to its highest position and raise the presser foot.
2. Loosen presser foot screw and remove the foot.
3. Hook new foot around the presser bar and tighten presser foot screw.

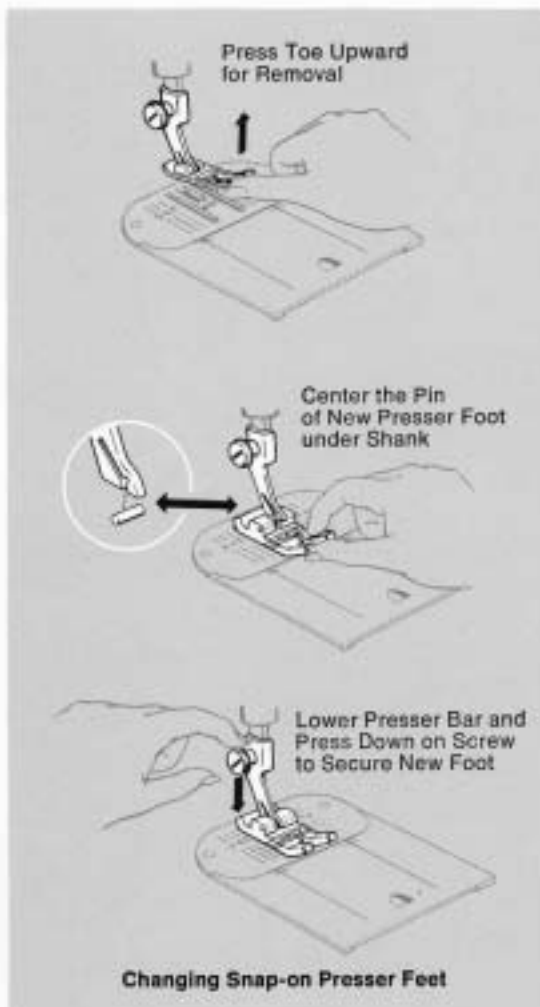

CHANGING PRESSER FEET

Snap-on Presser Feet

These presser feet snap on and off a common shank.

1. Raise needle to its highest position and raise the presser foot.
2. Press toe of presser foot upward (as far as it will go) and then snap down to remove.
3. Center the new presser foot under the shank and lower the presser bar so that the shank fits over the presser foot pin.
4. Press down on presser foot screw until foot snaps into place.

To remove and replace shank of snap-on presser feet, follow instructions below for one-piece presser feet.

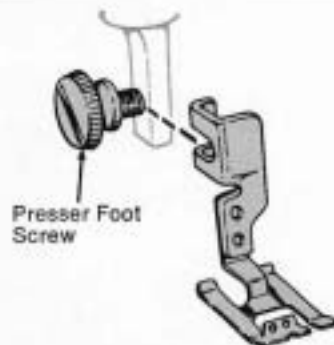

Changing One-Piece Presser Foot

One-Piece Presser Feet

1. Raise needle to its highest position and raise the presser foot.
2. Loosen presser foot screw and remove the foot.
3. Hook new foot around the presser bar and tighten presser foot screw.

THROAT PLATES

General purpose throat plate, in place in your machine, can be used with all presser feet.

Straight stitch throat plate for use with the straight stitch presser foot.

Chainstitch throat plate is one of three chainstitch fittings that must be used together. For instructions, refer to "Chainstitching" beginning on page 36.

Feed cover plate for use when fabric feeding is not desired.

CHANGING THROAT PLATE

(NOTE: Remove bobbin if it contains thread in order to prevent thread being caught when throat plate is replaced.)

1. Raise needle to its highest point and raise presser foot.
2. Open slide plate. Remove throat plate by placing thumb under plate and lifting it up and out.
3. Position new throat plate over the two pins and release. (Throat plate is drawn into position by magnets.)
4. Close slide plate.

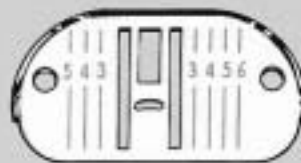

General Purpose Throat Plate

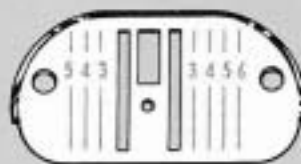

Straight Stitch Throat Plate



Chainstitch Throat Plate



Feed Cover Plate

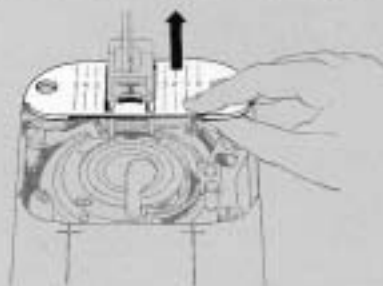

Changing Throat Plate

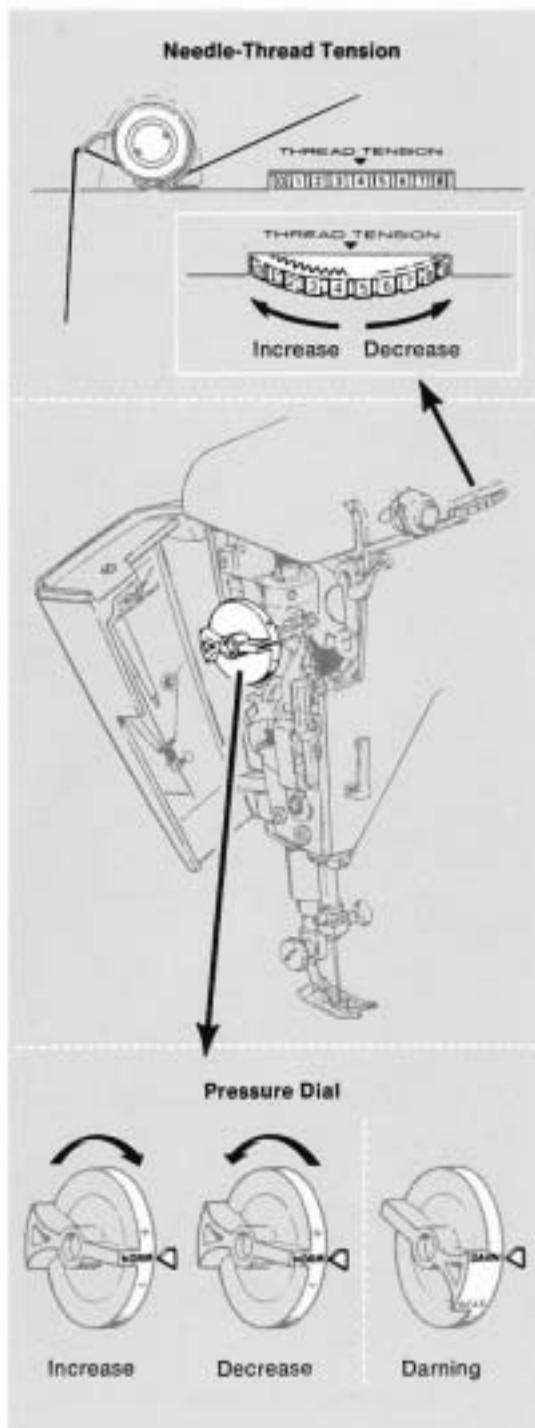

adjusting dials

REGULATING NEEDLE-THREAD TENSION

The tension dial regulates the degree of tension on your needle thread and lets you select just the right setting for your stitch, thread, and fabric. The **W** and **---** symbols indicate approximate tension ranges for zig-zag and straight stitching. The numbers eliminate guesswork in duplicating settings.

Correct tension is important because too much or too little will weaken your seams or mar the appearance of decorative work. To obtain the correct tension setting, make a test on a sample of your fabric. If the fabric puckers, decrease tension. If the stitches look loose, increase tension.

- **To increase tension**, turn dial to a higher number.
- **To decrease tension**, turn dial to a lower number.

NOTE: The tension dial controls needle-thread tension only. Bobbin-thread tension has been correctly set at the factory, and you do not need to adjust it.

REGULATING PRESSURE

The pressure dial regulates the pressure that the presser foot exerts on the fabric. Correct pressure is important because it means fabric feeds smoothly and evenly. The **NORM** (normal) setting is an all-purpose setting that can be used for sewing a wide variety of fabrics of different weights and textures. Intermediate notched settings, above and below **NORM** (normal), are also provided. When you need extra control to sew very heavy fabric, use the **MAX** (maximum) setting.

Lower the presser foot before setting pressure.

- **To increase pressure**, turn dial from **NORM** toward **MAX**.
- **To decrease pressure**, turn dial from **NORM** toward **DARN**.
- **For darning**, set dial on **DARN**.

SETTING STITCH LENGTH

The stitch-control dial regulates the length of both straight and zig-zag stitches. The numbers 6 to 20 represent the number of straight stitches per inch: *the higher the number, the shorter the stitch*. Generally, shorter stitches are best for lightweight fabric; longer ones for heavy fabric. Curved seams, bias-cut seams, and scallops require short straight stitches (15 to 20) for elasticity and smooth contours. Bound buttonholes should be sewn with a short stitch for durability and strength.

The **FINE** area, above 20, is used for the adjustment of zig-zag satin stitching (page 24) and speed basting (page 34).

When you are using a *Flexi-Stitch Disc*, the  setting controls stitch length; once it is set, no further adjustment is necessary.

NOTE: *Flexi-Stitch Disc 59* can also be used in the 6 through **FINE** stitch length range.

- **To set stitch control**, turn dial until setting desired is under red line.
- **For reverse stitching**, simply press reverse stitch lever all the way down and hold in place. Release lever for forward stitching.

ADJUSTING STITCH BALANCE FOR STRETCH STITCHING

When you use a *Flexi-Stitch Disc* for stretch stitching, you may need to adjust stitch balance in order to correct the appearance of the stitch and produce a strong seam. If the stitches are not correctly balanced, the stitching will not stretch with the fabric and will be irregular in appearance. Make a test sample to see whether adjustment is necessary (see illustration). If adjustment is required, stitch slowly and move the stitch balance dial as you sew until stitch formation is corrected.

- Turn the dial *toward you* to bring forward and reverse stitches of the pattern together.
- Turn the dial *away from you* to separate forward and reverse stitches of the pattern.

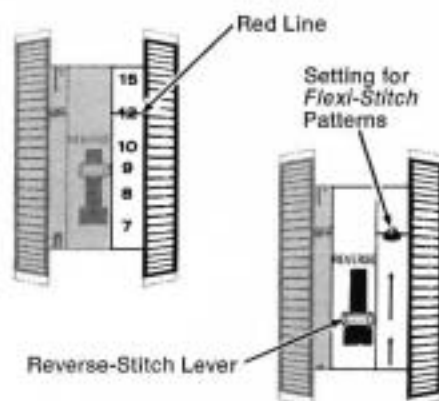

Stitch Control Dial

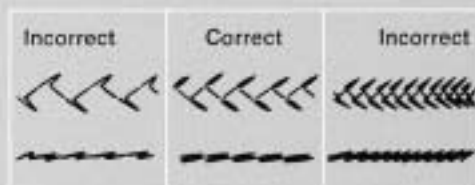
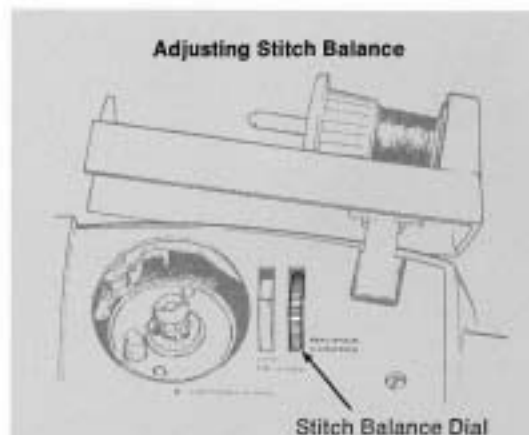

Turn Dial to Bring Stitches Together



Turn Dial to Separate Stitches



4. TIPS ON STRAIGHT STITCHING

To sew a straight stitch, set dials on black ▲ symbols.



- Set the stitch-control dial on a black number.
- Choose presser foot and throat plate to suit fabric and sewing procedure.

For information on straight stretch stitching, see pages 54 and 57.

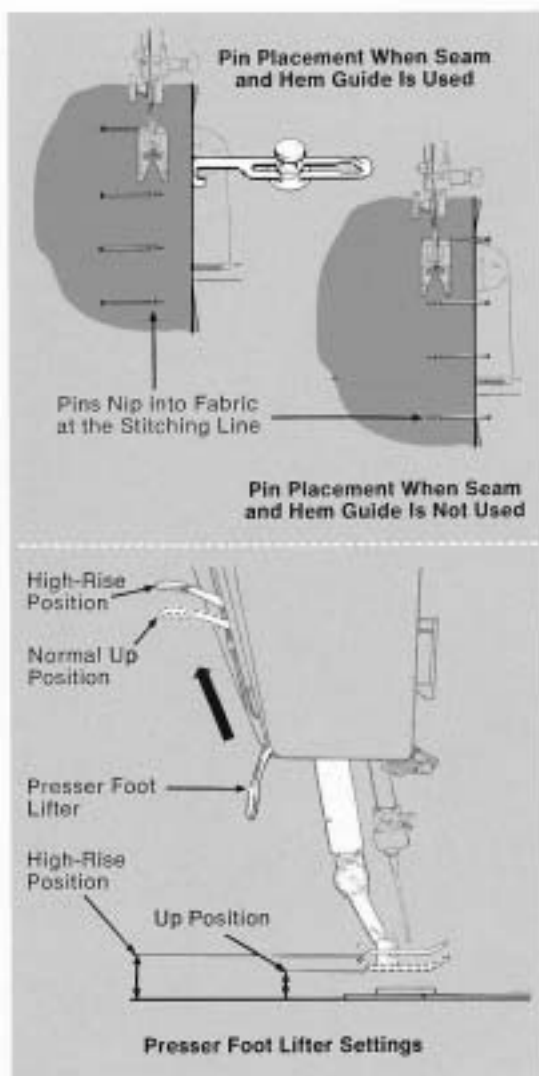

sewing a seam

PIN BASTING

Pin basting is a time saver and can be used in place of hand or machine basting when you are straight stitching seams in easy-to-handle fabric.

Use fine pins and place them so that:

- They are at right angles to the presser foot and just nip into the fabric at the stitching line.
- They do not extend under both sides of the presser foot. *Never place pins on the underside of the fabric in contact with the feed.*

For information on speed basting by machine, turn to page 34.

PLACING FABRIC

Most fabric can be placed under the presser foot by raising the presser foot lifter to its normal up position. When placing bulky fabrics, such as coating, knit or terry cloth, or multiple fabric layers, you will find it convenient to raise the presser foot lifter to the high-rise position. Hold lifter in position (since it does not lock) while placing fabric under the presser foot. Make sure the lifter is all the way down before starting to sew.

KEEPING SEAMS STRAIGHT

To keep the seam straight, use one of the numbered guidelines on the throat plate. The numbers indicate distance, in eighths of an inch, from the needle. If you want a $\frac{3}{8}$ -inch seam, for example, line up your fabric with the number 5 guideline. Note that both number 5 guidelines (the most commonly used) are extended on the slide plate for your convenience; the crosslines serve as cornering guides when stitching a square corner.

For extra help in keeping the seam straight, you may wish to use the seam and hem guide. Because it allows you to guide stitches between $\frac{1}{8}$ inch and $1\frac{1}{4}$ inches from the fabric edge, it is particularly useful for very narrow or unusually wide seams.

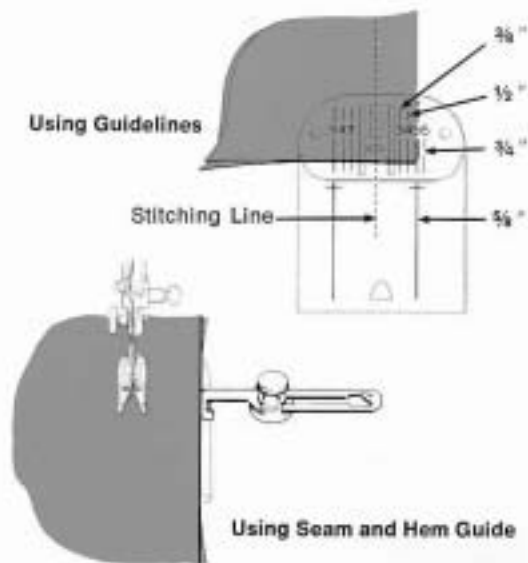

TURNING SQUARE CORNERS

To turn a square corner $\frac{3}{8}$ inch from the fabric edge, you need not measure or mark the seam. Simply use the crosslines on the slide plate.

- Line up your fabric with right or left guideline 5 on the throat plate. Stitch seam, slowing speed as you approach corner.

- Stop stitching, *with the needle down*, when the bottom edge of the fabric reaches the cornering crosslines on the slide plate.
- Raise presser foot and turn fabric on needle, bringing bottom edge of fabric in line with guideline 5.
- Lower the presser foot and stitch in new direction.

Pivoting at Corner

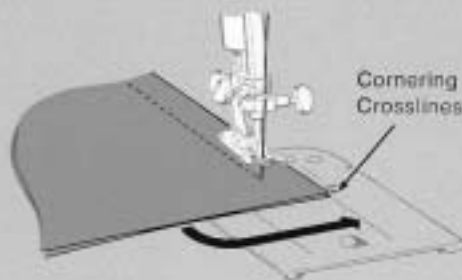

Fabric at Crosslines

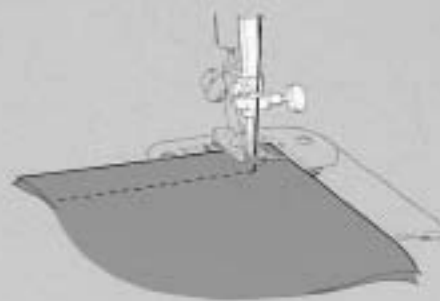

Fabric after Turning

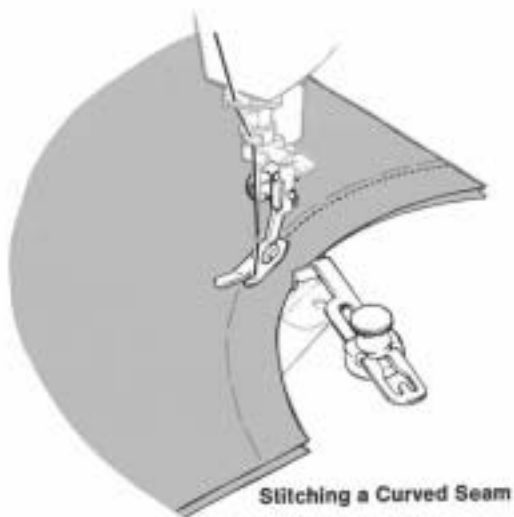

Stitching a Curved Seam

CURVED SEAMS

1. Use a short stitch for elasticity and strength. For example, if you use 12 stitches to the inch for straight seams, select 15 to 20 per inch to stitch curved seams in the same fabric.
2. Use the straight stitch foot for greatest accuracy.
3. If you use the seam and hem guide to guide stitching, attach it at an angle so that the edge that is closer to the needle acts as a guide.

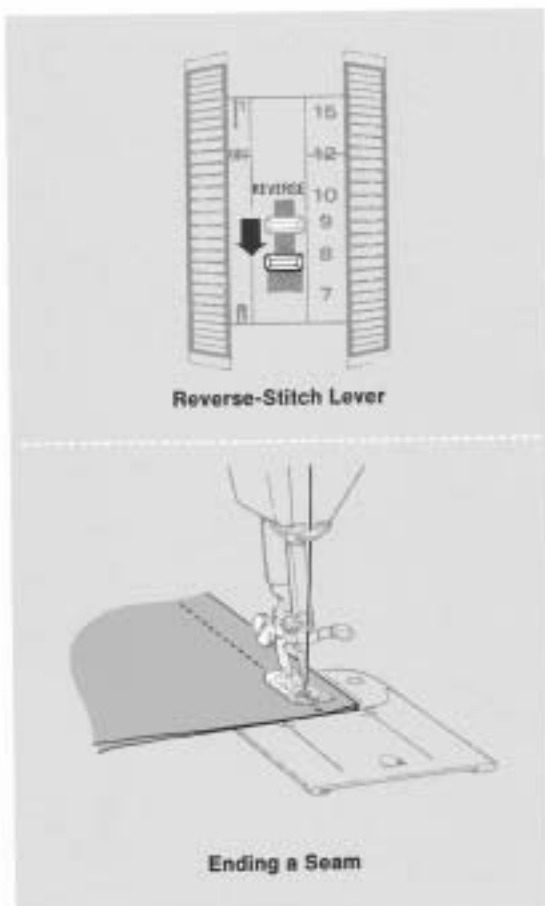

Reverse-Stitch Lever

REINFORCING END OF SEAM

1. Stitch to the edge of the fabric.
2. Press reverse-stitch lever all the way down and hold in place. Backstitch approximately $\frac{1}{2}$ inch to reinforce end of seam. Release lever.
3. Raise needle to its highest position, raise the presser foot, and remove the fabric by drawing it to the back and left.
4. Cut threads on thread cutter at rear of presser bar.

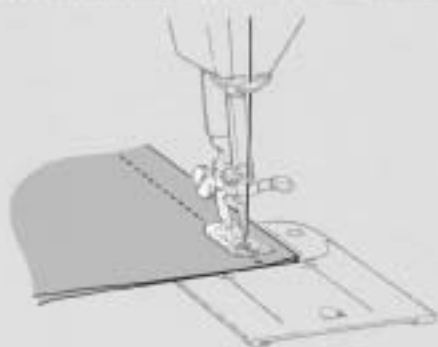

Ending a Seam

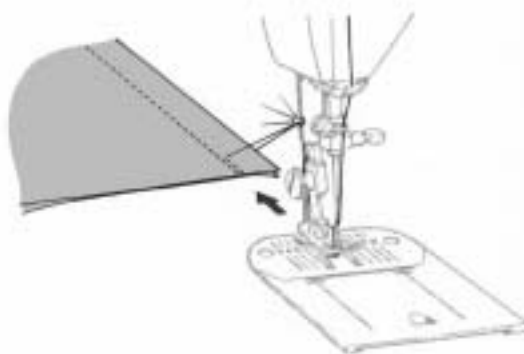

Cutting Threads

5. ALL ABOUT ZIG-ZAG STITCHING

how patterns are produced

All patterns are produced from discs. Some are built into your machine; others are interchangeable and can easily be inserted in the machine. In addition to the obviously decorative uses of the discs, some also serve very practical purposes. In the section called "Sewing the Professional Way" beginning on page 48, you will find instructions for both decorative and practical uses of these discs.

There are two kinds of interchangeable discs,

Fashion Discs and *Flexi-Stitch Discs*. The *Fashion Discs* (black), like those built into your machine, control the zig-zag movement of the needle. The *Flexi-Stitch Discs* (light-colored) control both the zig-zag movement of the needle and the forward-reverse stitching direction to produce multi-purpose and decorative patterns. Both *Fashion Discs* and *Flexi-Stitch Discs* can be combined with the built-in discs to create additional stitch patterns.

built-in zig-zag discs

The eight discs built into your sewing machine include six zig-zag patterns. The stitches they produce are illustrated below.



Plain Zig-Zag

Plain Zig-Zag Stitch. Used for button-holes, button sewing, bar tacks, and applique.

Ball Stitch. A decorative pattern for single- and twin-needle work.

Solid Pyramid. Perfect for ornamental borders and edges.



Ball Stitch



Solid Pyramid



Crescent Stitch

Crescent Stitch. Produces evenly spaced and perfectly formed scallops for decorative trim.



Multi-Stitch Zig-Zag

Multi-Stitch Zig-Zag Stitch. Lets you mend, join, and reinforce without bulk.



Blindstitch

Blindstitch. Indispensable for finishing hems and seams.

SETTING PATTERN DIAL

Before moving the dial, make sure buttonhole dial is in **OFF** position and needle is above fabric.

Push pattern dial in, and turn it until desired zig-zag stitch pattern is between the red lines.

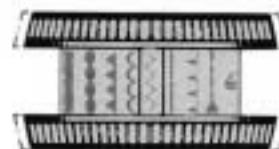

- Push In
- Rotate
- Release

ADJUSTING STITCH PLACEMENT

Before moving needle position dial, move stitch width dial to 5, and make sure buttonhole dial is in **OFF** position and needle is above fabric.

Needle position setting **A** places the needle in center stitching position. Settings **L** and **R** place the needle in left and right stitching positions at stitch widths less than 5.

Setting **A** is used most often. Settings **L** and **R** are for special placement of stitching.

For example, an **R** setting is required for two-step buttonholing and an **L** setting for button sewing and twin-needle work. An **L** or **R** setting can be used to place narrow zig-zag stitching to the left or right of center in decorative work.

To adjust stitch placement, turn needle position dial until desired setting is aligned with red line.

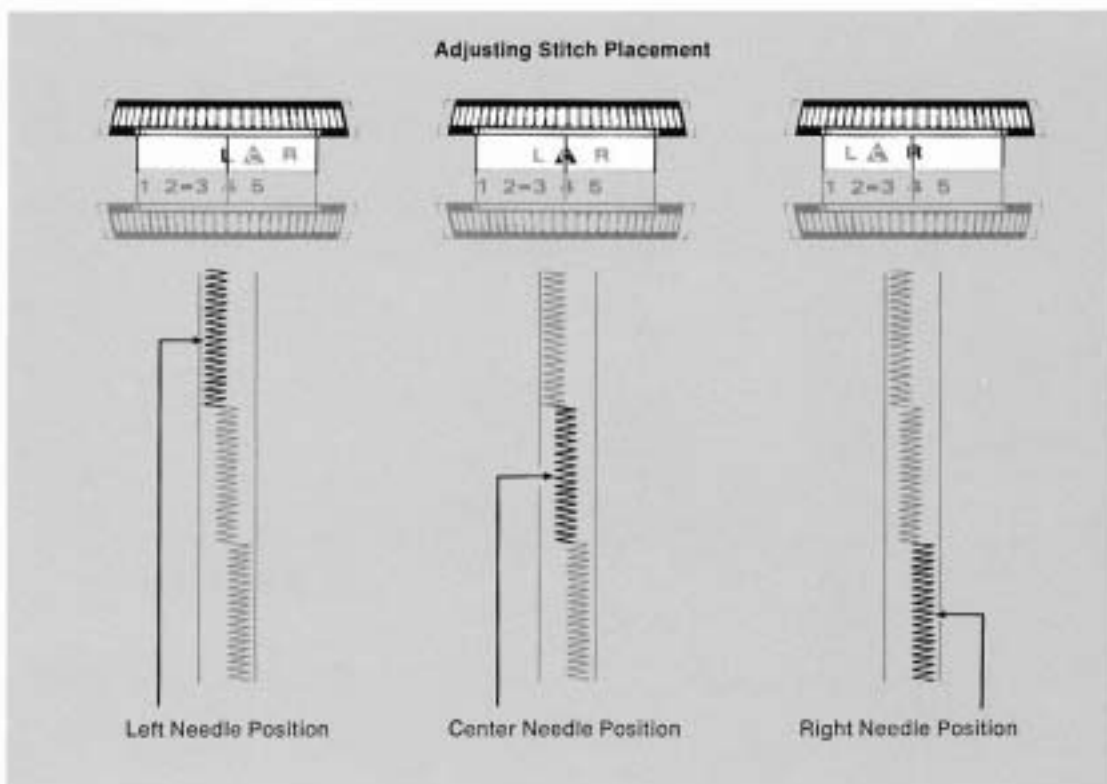

ADJUSTING WIDTH OF DESIGN

Before moving dial, make sure buttonhole dial is in **OFF** position and needle is above fabric.

To produce a zig-zag stitch, turn the stitch width dial to any setting between **1** and **5**. The higher the number, the wider the stitch.

ADJUSTING NEEDLE-THREAD TENSION

Zig-zag stitching requires less needle-thread tension than straight stitching. The *W* symbol on the tension dial indicates the approximate range of tension settings recommended for zig-zag stitching. Make a test sample with the fabric and thread you plan to use so that you can adjust the tension properly. The stitches should lie flat against the fabric without causing the fabric to pucker. If the stitches are not flat and the fabric is puckered, lower the needle-thread tension by turning the dial to a lower number.

ADJUSTING STITCH LENGTH

Any stitch length setting from **6** to **20** will give you an open zig-zag stitch of the pattern you select. The lower the number, the more open, or farther apart, your stitches will be. The symbol on the dial above **20** designates the **FINE** stitch area and is used for adjusting zig-zag satin stitching (see page 24 for specific instructions).

For instructions on *basting stitch*, see page 34.

TO FIND BEGINNING OF PATTERN UNIT

To start stitching at the beginning of a pattern unit, follow the instructions for interchangeable stitch pattern discs on page 26.

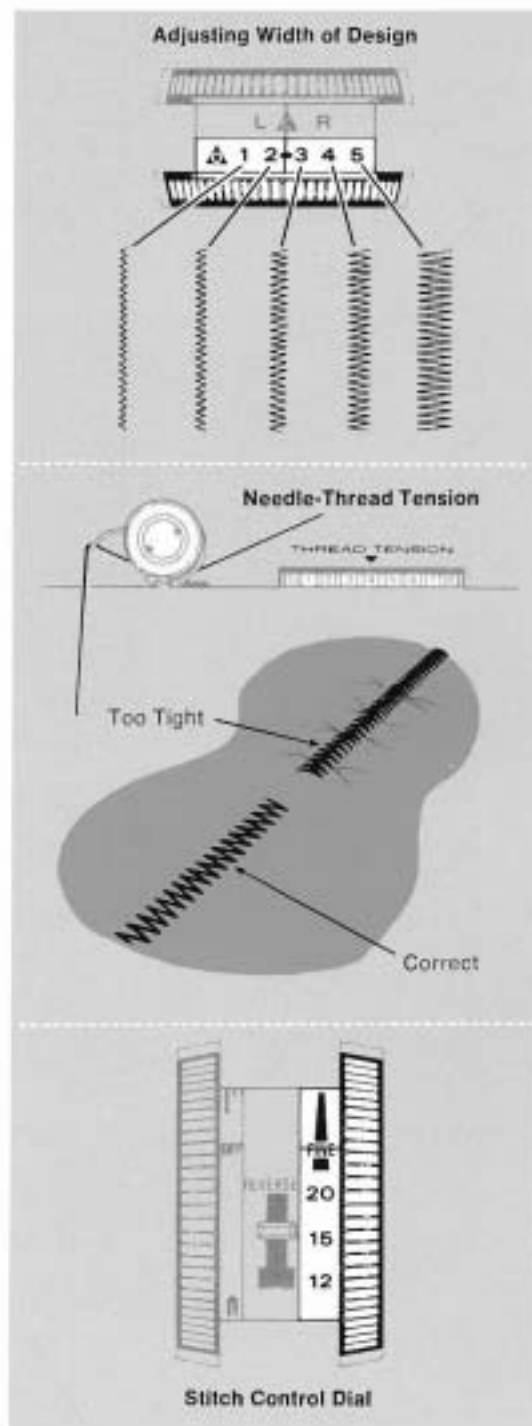

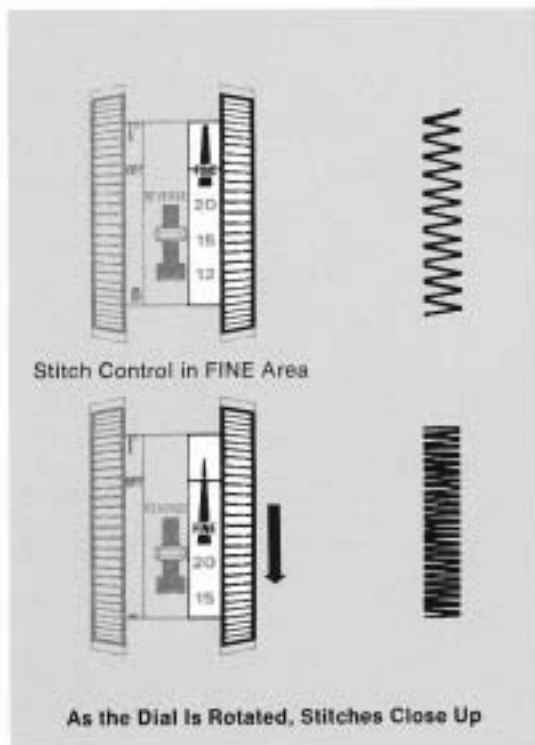

Stitch Control in FINE Area

As the Dial is Rotated, Stitches Close Up

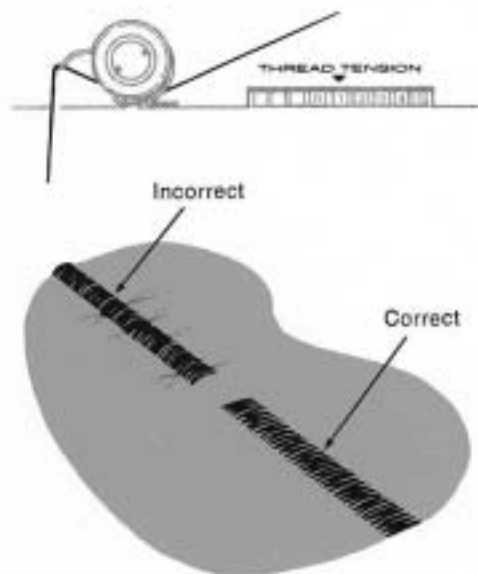

Adjusting Thread Tension

SATIN STITCHING

Satin stitching, a series of closely spaced zig-zag stitches that form a smooth, satin-like surface, is useful for both practical and decorative work. The plain zig-zag stitch, for example, is suitable for bar tacks and applique when closed up to form a satin stitch. Other built-in stitch patterns, many *Fashion Disc* patterns, and most combination patterns made with *Fashion Discs* can be sewn at satin stitch length.

When you wish to produce a satin stitch, make a test sample first so that you can adjust the stitch length and thread tension properly. Soft fabric may require a backing to ensure firm satin stitching. Crisp lawn or organdy is suitable for this purpose. For best results, use the special purpose foot.

Dial Settings

- Pattern: Desired zig-zag stitch or
- *Fashion Disc*: Desired pattern
- Stitch Width: 2 through 5
- Needle Position: , or **MIX** (for combination patterns made with *Fashion Discs*)
- Stitch Control: **FINE** area
- General Purpose Throat Plate
- Special Purpose Foot

Adjusting Stitch Length

1. Set stitch-control dial at bottom of **FINE** area.
2. Run machine at slow speed.
3. Gradually turn dial downward until stitches are closely spaced and form a smooth surface.

Adjusting Thread Tension

Satin stitching requires less tension than straight stitching or open zig-zag stitching. Furthermore, the wider the satin stitch, the lighter the tension on the thread must be. Notice the stitching on your sample. If the fabric is puckered, lower the needle-thread tension by turning the tension dial to a lower number.

Fashion discs

The eight interchangeable *Fashion Discs* that come with your machine produce the stitches illustrated below. Each of these stitches can be used to produce an attractive decorative motif.

To use these discs, simply insert the desired

disc (see next page for instructions), and set stitch pattern dial on . Adjust the needle position, stitch control and thread tension as you would when using a built-in disc.

To use a *Fashion Disc* in combination with a built-in disc, refer to page 30 for instructions.

FASHION DISC PATTERNS

Circled numbers indicate *Fashion Disc* numbers.

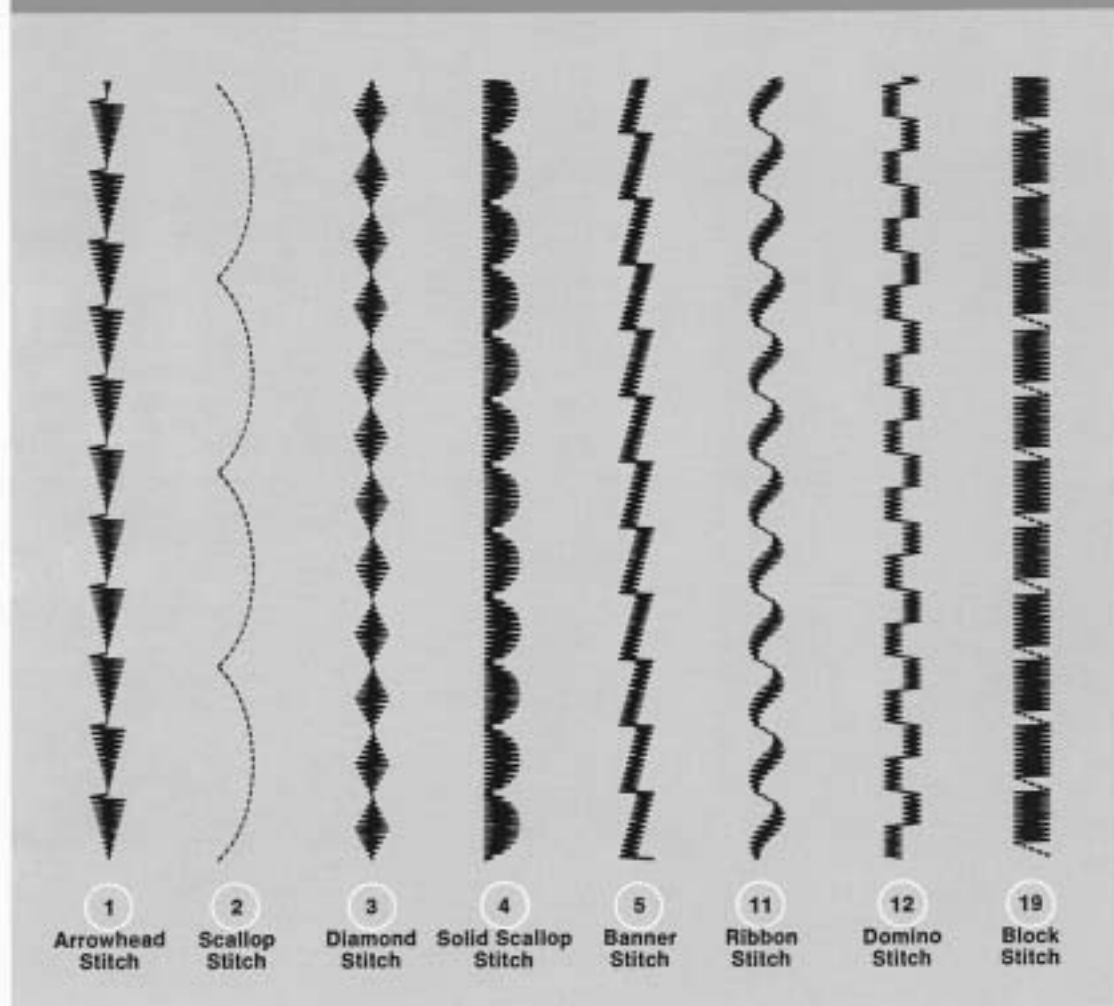

Changing Pattern Discs

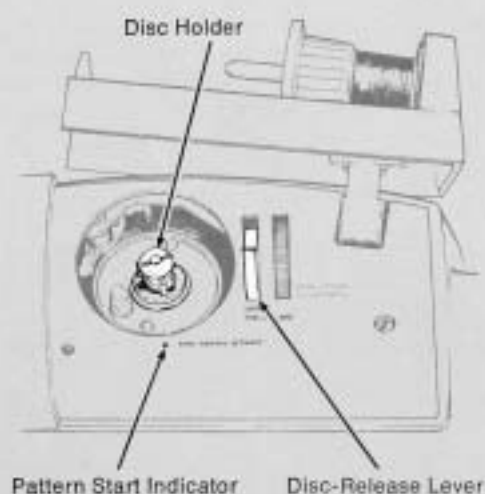

CHANGING FASHION AND FLEXI-STITCH DISCS

Make sure needle is above presser foot.

1. Open stitch chart cover.
2. Move pattern dial off  and make sure needle position dial is off **MIX**.
3. Press disc-release lever all the way back and *hold it back* while removing and replacing disc.
4. Remove disc from holder by pulling it upward.
5. Put new disc on holder, with opening in disc over post; press down until disc snaps into place.
6. Release disc-release lever.
7. Set pattern dial on  to activate disc.

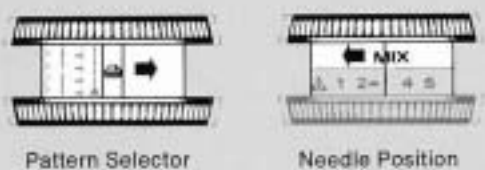

Starting at Beginning of Pattern Unit

If machine is threaded, place scrap of fabric under the presser foot and lower the foot.

To start stitching a *Fashion Disc* or *Flexi-Stitch Disc* pattern at its beginning, align the center of the disc holder post with the pattern start indicator . To do this, rotate the disc by pressing the speed controller or turning the hand wheel toward you; stop when the center of the post is in line with the indicator.

If there is a notch in the collar of your *Fashion Disc* (black), align the notch, instead of the disc holder post, with the pattern start indicator.

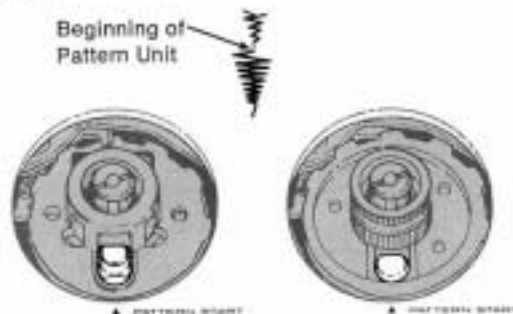
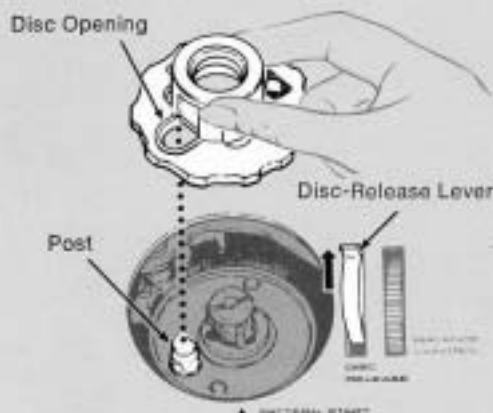

Starting at Beginning of Pattern Unit

Flexi-Stitch discs

The nine interchangeable *Flexi-Stitch* Discs that come with your machine produce the stitches illustrated below. To use a *Flexi-Stitch* Disc, insert it in the ma-

chine and set the stitch pattern dial on . Adjust needle position, stitch width, thread tension, stitch control, and stitch balance as instructed on following pages.

FLEXI-STITCH DISC PATTERNS

Circled numbers indicate *Flexi-Stitch* Disc numbers.

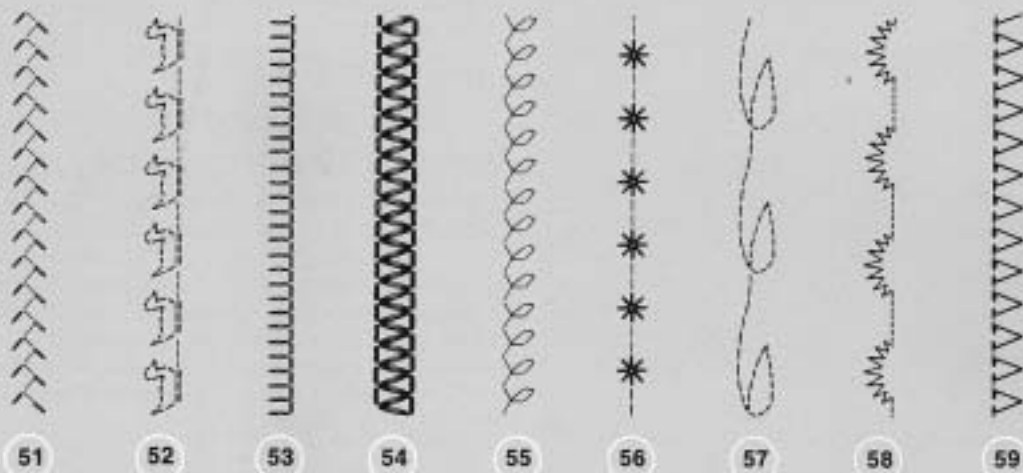

51 Feather Stitch. †

Multi-purpose and versatile. Use it for stretchable straight stitch seams in knit and stretch fabrics, for fagoting, embroidering and quilting, and to produce the ric-rac stitch.

52 Duck Stitch. †

A novel decorative design especially appropriate for children's wear.

53 Paris Point Stitch. †

Ideal for hemstitching, picot edging, drawn-thread work, and applique.

54 Turkish Hemstitch. †

For finishing and decorating hems in bed and table linens, joining, quilting and applique.

55 Multi-Stretch Stitch.

Appropriate for construction of garments made of knit, stretch, or elastic fabric.

56 Star Stitch. †

A traditional design motif with wide appeal and application.

57 Leaf Stitch.

For decorative stitching.

58 Sunburst Stitch.

Attractive for decorative borders.

59 Overedge Stretch Stitch. †

A flexible overedge seam finish that can be applied near or over the fabric edge in the construction of garments made of knit, stretch, or elasticized fabric.

†This stitch is designed for strength and permanence and cannot be readily ripped out without risk of fabric damage.

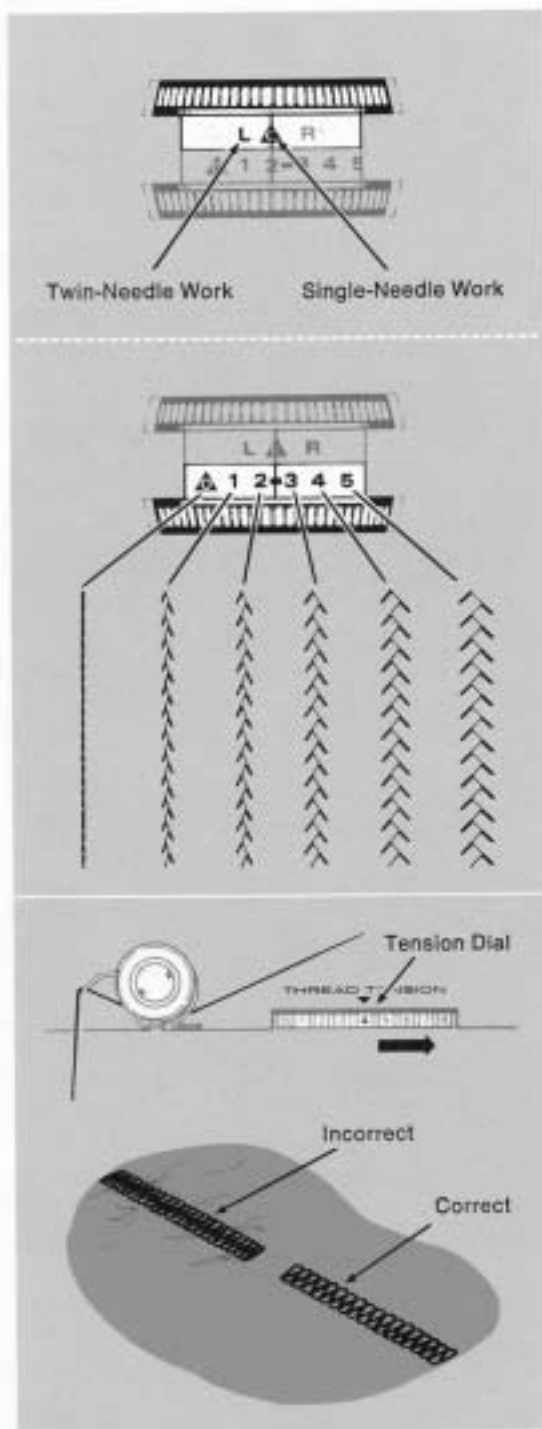

ADJUSTING STITCH PLACEMENT

Before moving the needle position dial, set stitch width dial on 5, and make sure button-hole dial is in OFF position and needle is above fabric.

Flexi-Stitch Disc stitching can be done in either L (left), center, or R (right) needle positions. Center needle position setting is recommended for single-needle work, but when a twin needle is used, L (left) setting must be used.

ADJUSTING WIDTH OF DESIGN

To produce the stitch pattern of a Flexi-Stitch Disc, the stitch width dial must be moved from the straight stitch setting to a setting from 1 to 5. The higher the number, the wider the stitch will be. For Turkish hemstitch, Paris point, and Star stitches, a setting of 2 or more is recommended. On setting , all width is removed from Flexi-Stitch Disc patterns and straight stitches are produced.

ADJUSTING NEEDLE-THREAD TENSION

Some Flexi-Stitch Disc patterns require more needle-thread tension than others. Make a test sample with the fabric and thread you plan to use so that you can adjust tension to suit the stitch you have chosen.

Set the tension dial on 3 or 4 for your test sample. Notice the stitching. If the fabric puckers, decrease tension by turning the dial to a lower number.

SETTING STITCH LENGTH

When you use a *Flexi-Stitch* Disc, stitch length is controlled with a single setting of the stitch control dial. Rotate the dial downward past the arrows (↑) where a slight resistance will be felt. Continue rotating dial until the 🍷 setting is centered under the red line.

NOTE: *Flexi-Stitch* Disc 59 can also be used in the 6 through FINE stitch length range.

Stitching cannot be reversed when stitch control dial is set on 🍷 .

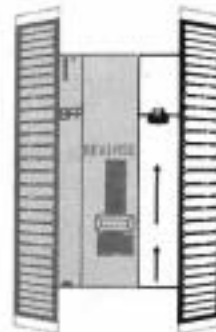

ADJUSTING STITCH BALANCE

You may need to adjust the forward-reverse parts of your pattern when using a *Flexi-Stitch* Disc in order to achieve the correct stitch pattern (see illustration).

Before you move the stitch balance dial from its neutral position (red line at approximately center), make a test sample. If adjustment is required, stitch slowly and move the stitch-balance dial as you sew.

- Turn the dial *toward* you to bring forward and reverse stitches of the pattern together.
- Turn the dial *away from* you to separate forward and reverse stitches of the pattern.

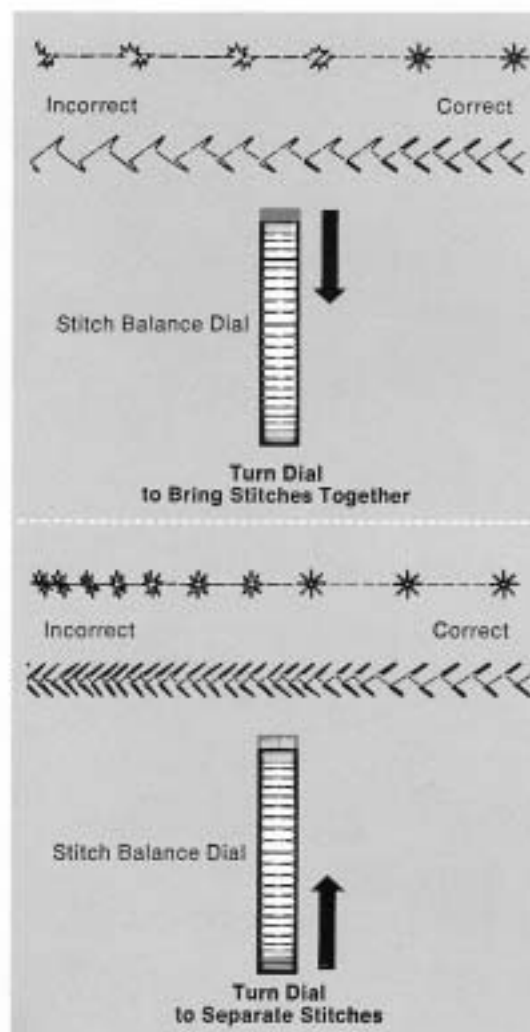
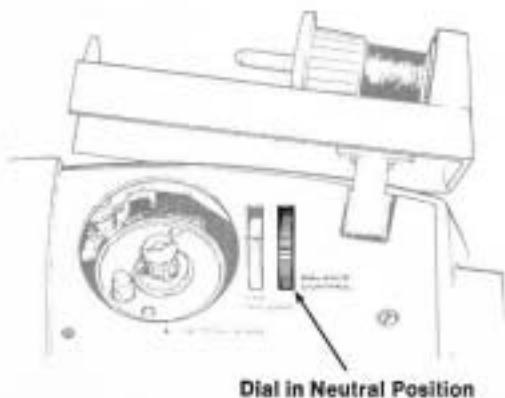

combination patterns

You can create additional practical and decorative stitch patterns by using a built-in disc with a *Fashion Disc* or a *Flexi-Stitch Disc*. It is possible to do this (even though the pattern dial cannot be set in two places at once) by using the special **MIX** setting† of the needle position dial. A few of the many combination patterns that can be created in this way and their dial settings are charted below. Other patterns are produced by varying stitch control and stitch width settings. You will find it

interesting to experiment with the many combinations available.

†NOTE: *Flexi-Stitch Discs* can also be combined with built-in discs by using the **L**, **A** or **R** needle position settings.

Before moving the dials, make sure the needle is above the fabric.

When turning the needle position dial to the **MIX** setting, the dial will be easier to turn if you first set the stitch width dial on **5**.

COMBINATION PATTERN CHART							
To produce patterns at right, use settings and discs shown below							
Pattern Dial							
Fashion Disc or Flexi-Stitch Disc No.	58	51	51	51	56	12	2
Stitch Width	5	5	5	0	5	2	2
Needle Position	MIX	MIX	MIX	MIX	MIX	MIX	MIX
Stitch Control						FINE	FINE

††This stitch is designed for strength and permanence and cannot be readily ripped out without risk of fabric damage.

6. TWIN-NEEDLE STITCHING

By using a twin needle, you can produce two parallel, closely spaced lines of decorative stitching simultaneously. You can choose either a straight stitch setting, one of the built-in patterns, or any *Fashion Disc* or *Flexi-Stitch Disc* pattern. Combination patterns that can be produced with an **L** needle position setting can also be used. (Combination patterns produced on a **MIX** setting *cannot* be used.)

preparation

1. Fill bobbin with enough thread to complete stitching. (Since a bobbin cannot be filled after a twin needle is inserted, it is wise to keep an extra wound bobbin at hand for replacement.)
2. Close slide plate, and pull out a loop of thread between the needle and bobbin.
3. Cut thread about four inches from needle hole, and unthread the machine.
4. Remove the single needle and insert the twin needle.

NOTE: When inserting a previously wound bobbin, follow the instructions on page 10.



Best twin-needle stitching results are obtained with No. 50 mercerized cotton thread

threading the needle

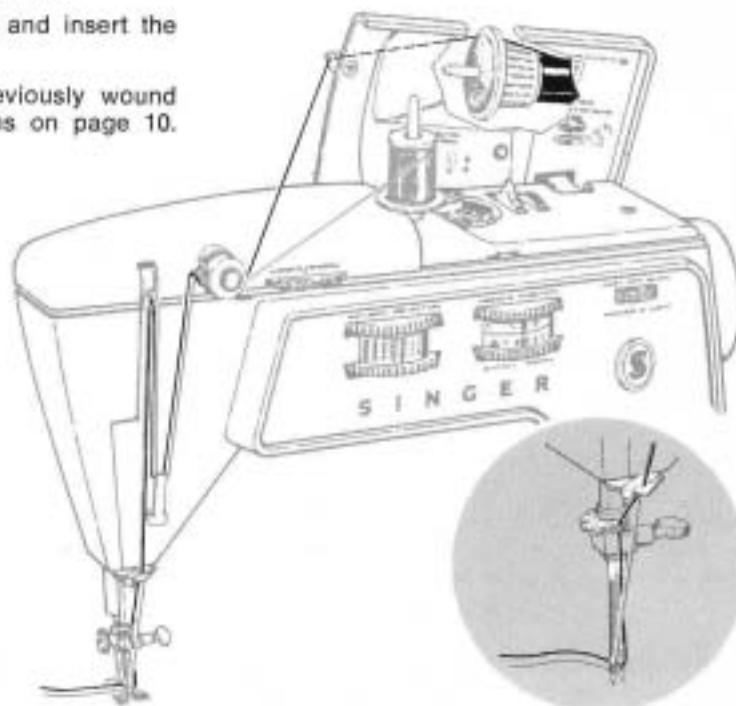

1. Thread as for one-needle stitching *except*:
 - Pass thread between *center* and *back* tension discs, through the thread guide above the needle, and through *right* eye of needle.
2. Raise stitch chart and insert detachable spool pin into hole provided for it.
3. Place spool of thread on detachable spool pin and thread as for one-needle stitching *except*:
 - Do not attempt to pass thread through guide on top of stitch chart cover.
 - Pass thread between *center* and *front* tension discs and through *left* eye of needle, *omitting the thread guide above the needle*.

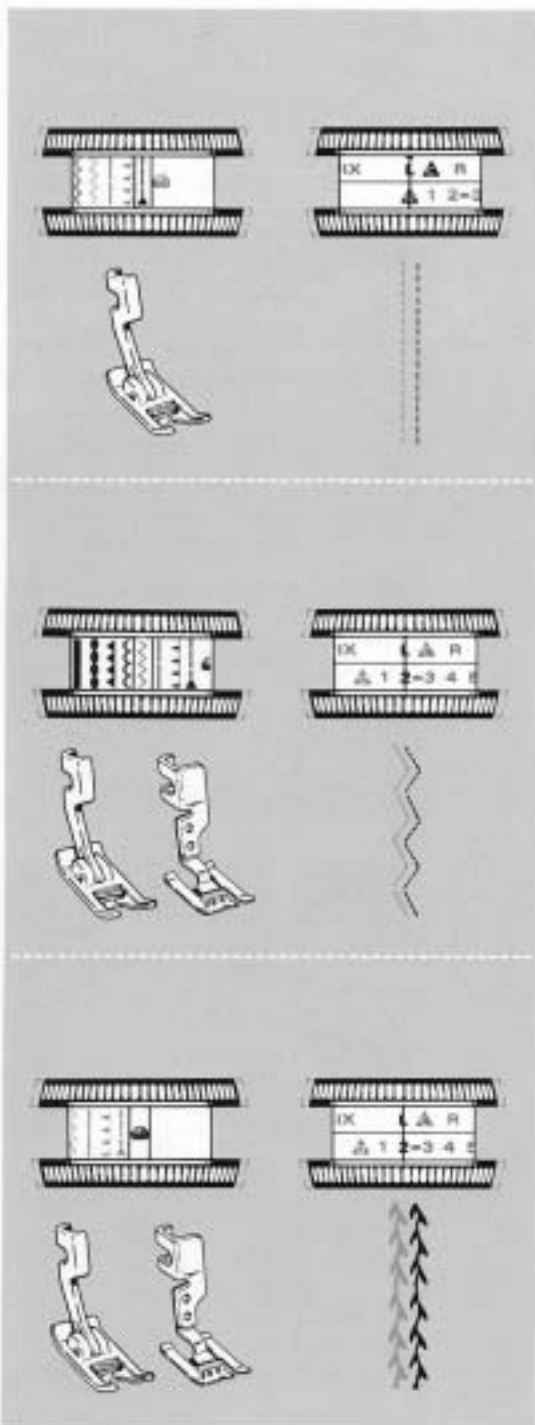





dial settings

STRAIGHT STITCHING WITH A TWIN NEEDLE

- Pattern: Straight Stitch 
- Stitch Width: 
- Needle Position: L or  only
- Stitch Control: 6 to 20
- General Purpose Throat Plate
- General Purpose Foot

BUILT-IN AND FASHION DISC STITCHING WITH A TWIN NEEDLE













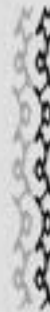





- Pattern:  through 
- Fashion Disc: All Patterns
- Stitch Width: 2
- Needle Position: L only
- Stitch Control: 6 through FINE
- General Purpose Throat Plate
- General Purpose Foot (for open stitching)
- Special Purpose Foot (for satin stitching)

† | Basting excepted

FLEXI-STITCH DISC STITCHING WITH A TWIN NEEDLE

- Pattern: 
- Flexi-Stitch Disc: All Patterns
- Stitch Width: 2
- Needle Position: L only
- Stitch Control: 
- Stitch Balance: Equalized
- Speed: In SLOW range
- General Purpose Throat Plate
- General Purpose Foot or Special Purpose Foot

decorative twin-needle stitching

To produce patterns at right, use settings and discs shown below					
					
	 51	 51	 51	 19	 11
	2	2	2	2	2
	L	L	L	L	L
				FINE	FINE

†This stitch is designed for strength and permanence and cannot be readily ripped out without risk of fabric damage.

turning a square corner

Geometric twin-needle designs are easy to accomplish with the plain zig-zag stitch when you know how to turn a square corner. Be sure to practice turning in right and left directions. See page 32 for dial settings.

- Stitch to the corner and stop with the needle in the fabric on the *inside* of the corner.
- Raise the presser foot and turn the fabric halfway around the corner (needle in fabric). Lower the foot and take one stitch by turning the hand wheel. Continue to turn the hand wheel until needle is *about to enter* fabric on the *inside* of the corner.
- Raise the foot again and complete the fabric turn, positioning the work under the foot so that the needle will enter the *inside* corner needle hole a *second time*.
- Lower the foot and continue stitching in the new direction.

7. TEMPORARY STITCHING

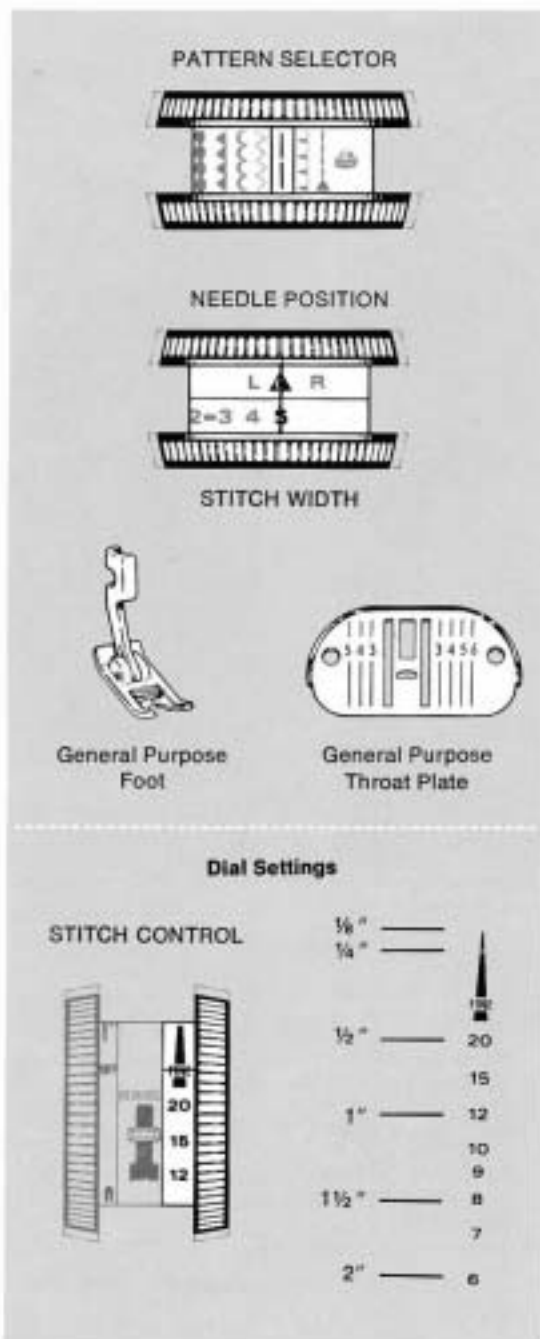

speed basting

With the basting stitch that is built into your sewing machine, you can produce basting stitches of any length up to two inches. Thus, you can choose just the right length for your sewing job, considering the weight of your fabric and how securely the pieces need to be held together. A few of the many sewing jobs for which you will find speed basting particularly useful are:

- Joining seams for trial fittings
- Marking construction guidelines
- Basting pleats, hems and seams

DIAL SETTINGS AND ACCESSORIES

- Pattern: Basting Stitch
- Stitch Width: 5 only
- Needle Position:  only
- Stitch Control: 6 through FINE
- Speed: In SLOW range
- General Purpose Throat Plate
- General Purpose Foot

Stitch Length

The stitch-control dial regulates the length of basting stitches, but because the basting disc changes the interval at which the needle enters the fabric, the numbers on the dial no longer represent stitches per inch.

The settings of the control dial and the approximate length of the basting stitches they produce are illustrated. The very short stitches produced in the triangle at the top of the FINE area are used to position stitching starts.

Thread Tension

Machine basting requires a light needle-thread tension. Use settings in the *W* range on the tension dial. *The longer the stitch, the lighter the tension needs to be.* When tension is correctly adjusted, stitches up to ½ inch long should lie flat in firm fabrics. If stitches are more than ½ inch long, place tension on the fabric by holding it in front and back of the presser foot, as you sew, to prevent pucker.

PREPARATION

Thread the machine and fill the bobbin in the usual way. Select needle and thread according to your fabric: mercerized cotton threads are particularly recommended. Choose a thread color to contrast with your fabric so that it can be seen easily. *Make sure the general purpose foot and general purpose throat plate are on the machine and the needle is in its highest position.*

PROCEDURE

1. Set stitch control for a short stitch in the triangle at the top of the **FINE** area on the dial. Place work under the needle, lower the presser foot, and take a few stitches to position and secure basting start.
2. Reset stitch control dial for the length of basting stitch desired (stitches less than 1 inch long are recommended for seam basting) and proceed as for regular sewing. Stitch slowly, supporting the fabric in front and back of the presser foot if stitches are more than ½ inch long.
3. To secure the end of basting, turn dial downward for a short stitch in the **FINE** area and take a few stitches.

To avoid pressing marks, remove basting stitches as soon as they have served their purpose.

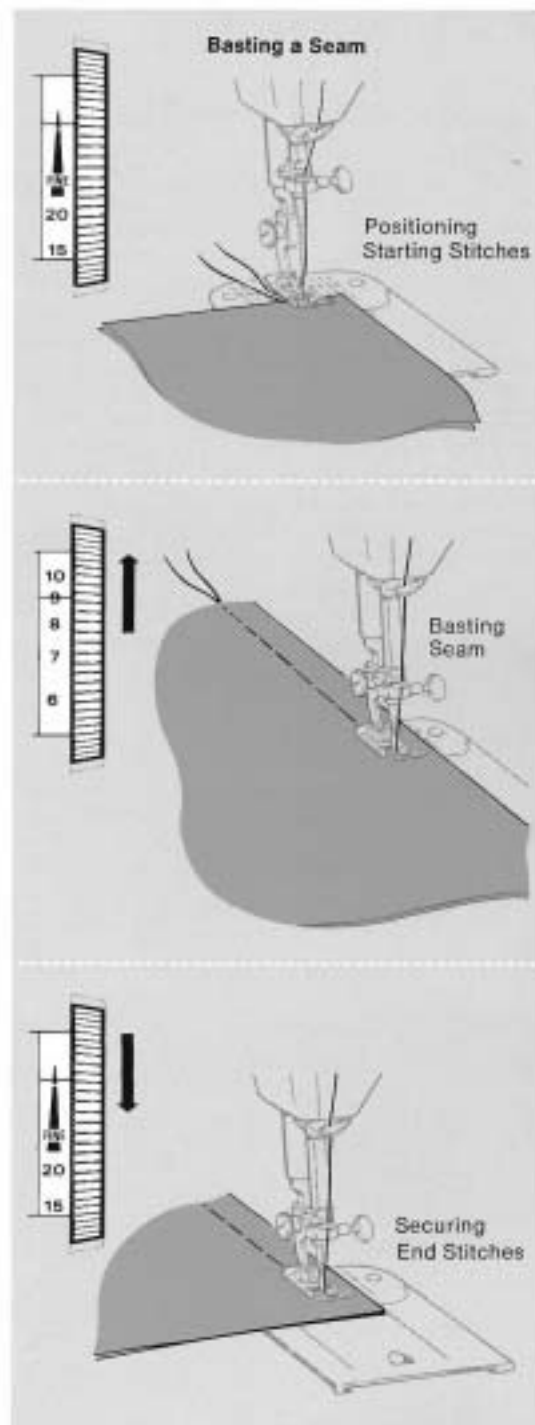

chainstitching

Single-thread chainstitching looks like regular straight stitching on top but is a series of interlocking loops on the underside of the fabric. The stitches are produced by the needle thread alone so you do not need a bobbin thread or a bobbin. Because the stitches are formed by a single thread, the interlocked loops unravel easily, allowing the entire line of stitching to be removed with just a pull on the thread end. Also, the loop formation of the stitches makes them less taut than regular straight stitches. That's what makes chainstitching flexible.

Here are a few of the many sewing jobs for which you will find chainstitching useful. (For further information on some of these chainstitching applications, see page 72.)

- Sewing temporary hems and tucks to extend the life of —
 - Children's clothes
 - Curtains and linings that might shrink
- Hemming curtains and draperies that may need to be altered.
- Attaching woven and stretch hem tape.
- Making stay chains (French tacks) to anchor linings or belt carriers to hold belts in place.
- Fastening removable trimming —
 - Fur collars
 - White collars and cuffs
- Basting for trial fittings.

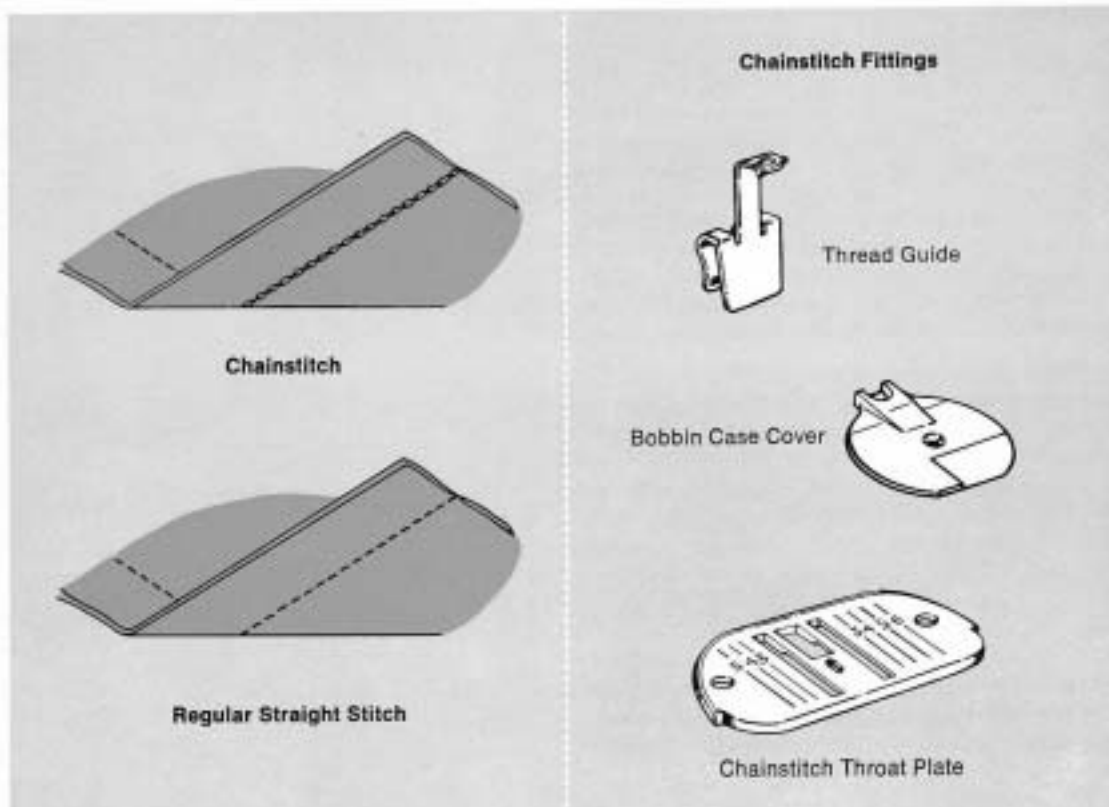

PREPARATION

Make sure needle is at its highest point.

1. Raise presser foot, open slide plate, and remove bobbin.
2. Remove throat plate and position chainstitch throat plate over pins from front.
3. Insert bobbin case cover in bobbin case with flat edge toward the front as illustrated. Snap latch down and close slide plate.
4. Open face plate and slip chainstitch thread guide into place. Close face plate.
5. Thread your machine in the usual way except pass thread from take-up lever through self-threading eyelet in the chainstitch thread guide.

Soft, pliable threads of light and medium weight are most suitable for chainstitching. No. 50 mercerized cotton and "A" silk used in a size 14 needle are recommended.

6. Adjust thread tension. Chainstitching requires approximately the same needle-thread tension as regular straight stitching, provided the same kind of thread is used. When the tension is correctly adjusted, the chain will be flat and smooth. Puckers in the fabric and pinched loops indicate too much tension; turn tension dial to a lower number. Large, irregular loops indicate too little tension; turn tension dial to a higher number.

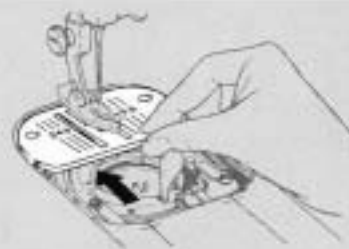

Insert Throat Plate

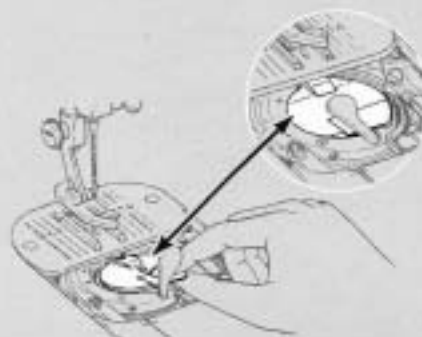

Position the Bobbin Case Cover

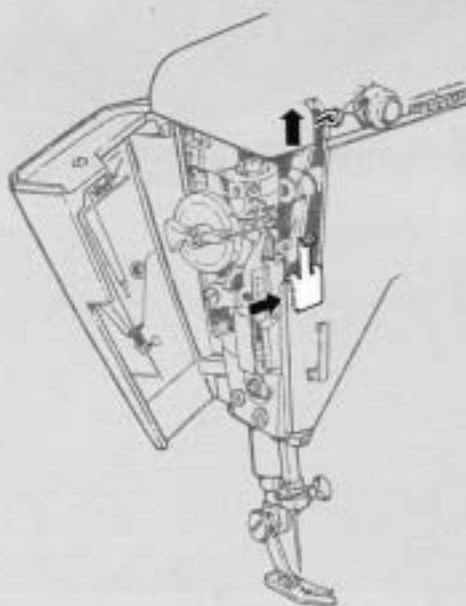

Attach the Thread Guide

SEWING A CHAINSTITCH SEAM

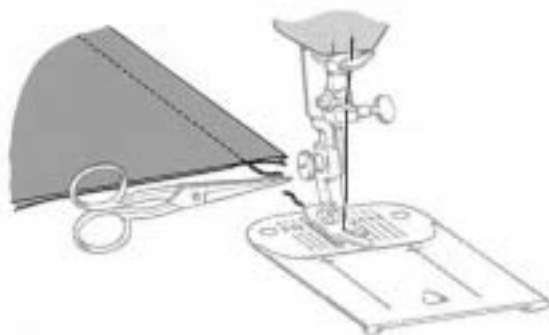

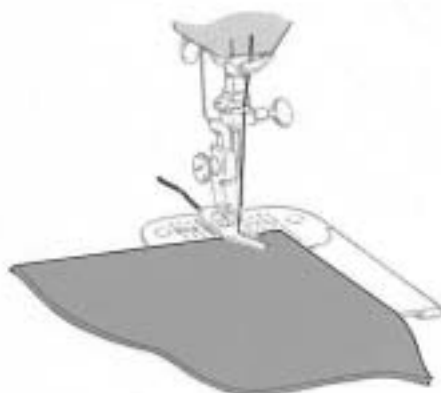

Chaining Off

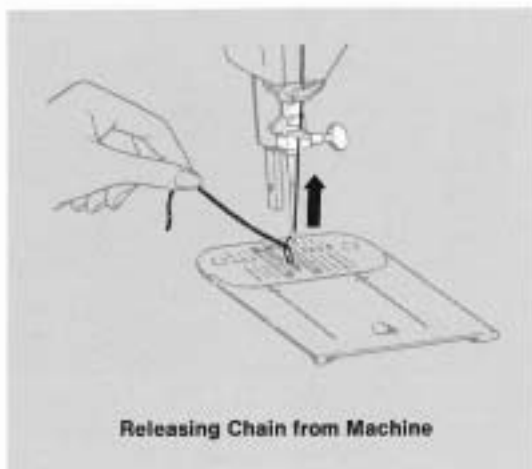

Stitch Starting Point after Chaining Off



Releasing Chain from Machine

- Pattern: Straight Stitch
- Stitch Width: 
- Needle Position: 
- Stitch Control: 10 to 12 only
- Chainstitch Throat Plate
- Straight Stitch Foot or General Purpose Foot
- Chainstitch Thread Guide
- Bobbin Case Cover

Starting and Chaining Off

1. Turn hand wheel toward you to position needle in very edge of fabric. Lower the presser foot.
2. Start the machine and stitch to end of seam. Continue stitching beyond edge of fabric, making a chain from one to two inches long. *Do not attempt to stitch in reverse.* Chainstitching can be sewn in a forward direction only.
3. Cut chain between fabric and presser foot.
4. After chaining off, start a new line of stitching by raising the presser foot slightly and positioning the fabric in front of the needle. Lower the presser foot and stitch to end of seam.

Releasing the Chain from the Machine

When you finish chainstitching, the chain can easily be removed from the machine.

1. Raise presser foot.
2. Hold end of chain with your left hand.
3. Turn hand wheel slowly toward you with your right hand until needle is all the way down in the needle hole.
4. Then turn hand wheel slowly away from you, pulling gently on chain, which will unravel as needle rises.

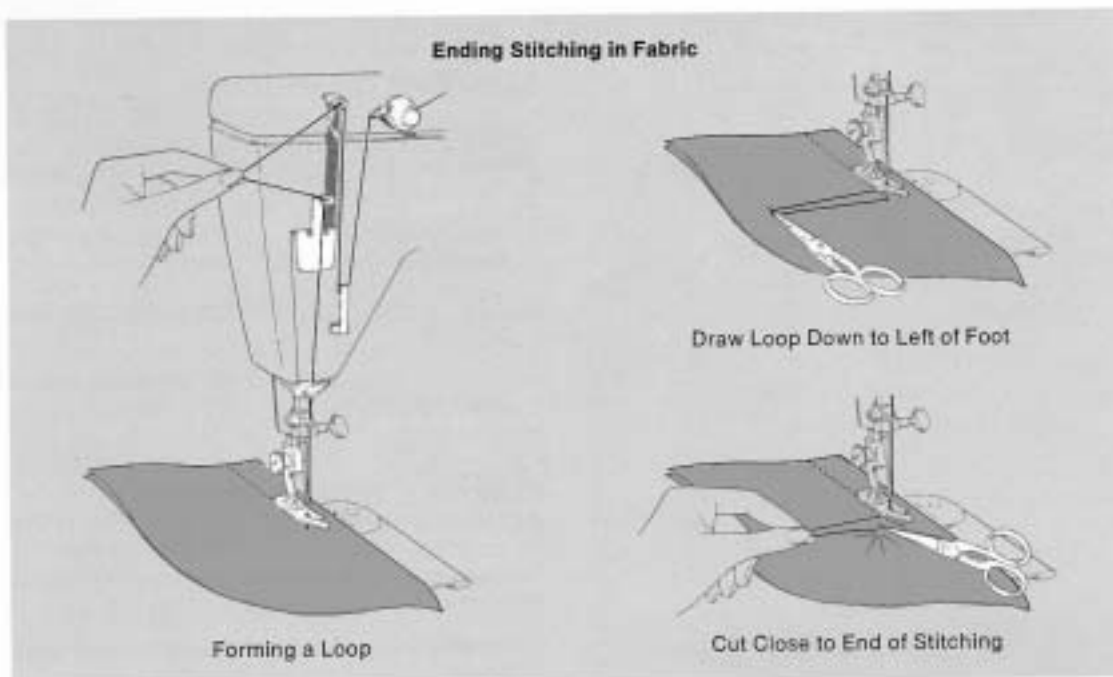

Ending the Stitching in the Fabric

Occasionally, you may need to end your stitching in the fabric. Temporary hems and tucks, for example, can be completed in this way:

- Stop stitching at desired point. Make sure take-up lever is in its highest position.
 - Raise presser foot.
1. Pull the thread through the take-up lever, forming a loop between the take-up lever and chainstitch thread guide.
 2. Pass scissors under the presser foot so as to pull the slack thread down and out to form a loop at left of foot.
 3. Hold the loop and cut the thread close to the end of the stitching.
 4. Remove fabric from machine by pulling it straight back, away from you. The thread end will pull through the fabric to the underside and form a temporary lock.
- If you wish to secure this temporary lock, fold the thread end back over the chain and fasten with hand stitching.

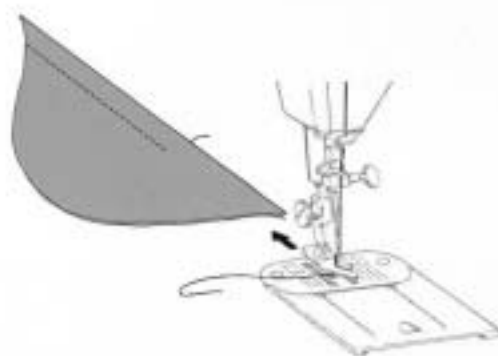

Removing Fabric



Securing Temporary Lock

Removing the Stitching

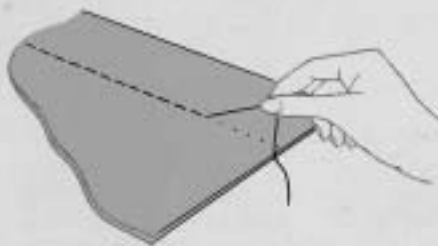
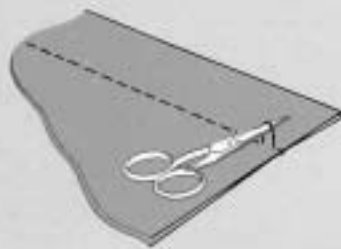
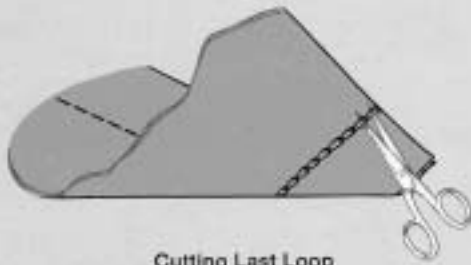

REMOVING THE STITCHING

Chainstitching can be removed smoothly and cleanly in seconds by freeing the last stitch formed in the fabric.

1. Simply cut the last loop formed on the underside of the fabric.
2. Pick up the free thread end from the top surface of the fabric.
3. Pull the free thread end, removing entire line of stitching.

REMOVING THE CHAINSTITCH ACCESSORIES

Release thread chain from machine and *make sure needle is at its highest point.*

1. Open slide plate and remove bobbin case cover.
2. Replace bobbin and snap down latch.
3. Remove throat plate by pressing up and lifting it out toward you.
4. Replace general purpose or straight stitch throat plate.
5. Open face plate and remove chainstitch thread guide. Close face plate.

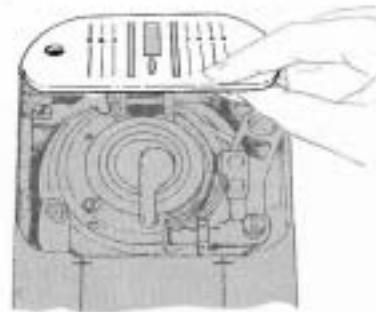

8. BUTTONS AND BUTTONHOLES

buttons

- Pattern: Plain Zig-Zag
- Stitch Width: Δ and 4
- Needle Position: L
- Feed Cover Throat Plate
- Button Foot

The space between the holes in the button determines stitch width settings. The Δ setting must always be used to position the button and to fasten stitching. For buttons with standard hole spacing, settings Δ and 4 are usually satisfactory. For buttons with unusual hole spacing, use setting Δ and increase or decrease the width setting (4) as necessary.

1. Position button under button foot and lower the needle into center of left hole. Lower the foot. Turn hand wheel toward you until the needle rises out of the button and is just above the foot.
2. Set stitch width at 4. Then, when you begin to stitch, the needle should enter the

right hole of button. Take six or more zig-zag stitches at this setting. End on left side.

3. To fasten stitching, return to stitch width setting Δ and take about three stitches.

FORMING A THREAD SHANK

Buttons sewn on coats and jackets should have a thread shank to make them stand away from the fabric. To form a thread shank, sew over the blade of a regular machine needle.

- Position button and lower button foot. Place needle in groove of foot so that point enters the hole in the foot. *The farther in you push the needle, the longer the shank will be.*
- After stitching, remove needle from groove. Remove work from under presser foot, cutting threads about six inches from fabric. Pull needle-thread ends to back of button and form a firm shank between button and fabric by winding threads tightly around attaching stitches. Tie thread ends securely.

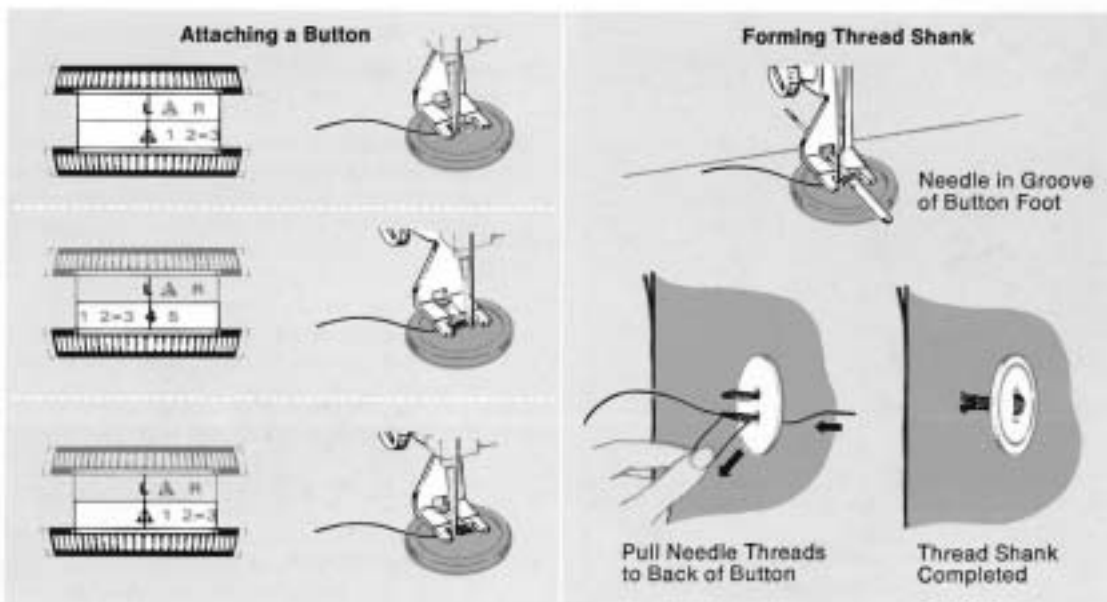

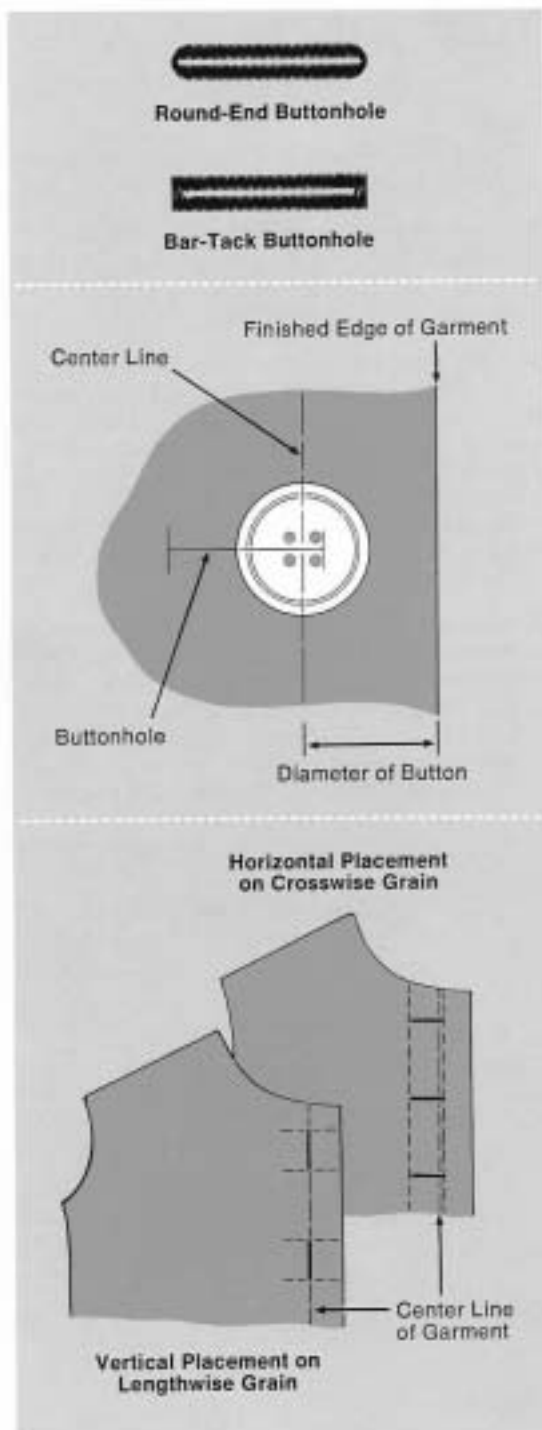

buttonholes

You have a choice between two buttonhole styles and two buttonhole-making methods: round-end buttonholes, made with the built-in buttonhole system of your machine, and bar-tack buttonholes with square-ends made manually in four steps. Round-end buttonholes can be made in light- and medium-weight fabric; bar-tack buttonholes are best in lightweight fabric.

BUTTONHOLE POSITION

Accurate guidelines are essential to keep buttonholes at a uniform distance from the edge of the garment, evenly spaced, and on the grain of the material.

1. Mark the center line of the garment. This guideline can be made by hand basting or machine speed basting. The space from the center line to the finished edge of the garment must be at least equal to three-quarters the diameter of the button. With this spacing, the button will not extend beyond the edge when the garment is buttoned. Make sure that the center line marking follows a lengthwise fabric thread.
2. Mark a position guideline for each buttonhole.
 - **Horizontal** buttonholes are placed to extend $\frac{1}{8}$ inch beyond the center line of the garment, as illustrated, so that the buttons will be in the center of the figure when the garment is fastened. Horizontal buttonhole guidelines should follow a crosswise fabric thread and be longer than the finished length of the buttonhole. Mark ends of each buttonhole vertically.
 - **Vertical** buttonholes are placed so that the center line of the garment is in the center of the buttonhole, as illustrated. Mark the ends of each buttonhole horizontally across the center line basting and use the center line marking as the buttonhole guide when stitching.

BUTTONHOLE LENGTH

A buttonhole length should be just long enough to allow the button to slip through the opening without stretching it. You can estimate the proper buttonhole length by measuring the width plus the thickness of the button. To make sure the measurement is correct, cut a slit in a scrap of fabric the diameter of the button you intend to use. Increase length of opening until button slips through easily. This test is particularly advisable for buttons of unusual shape or thickness.

BUTTONHOLE INTERFACING

It is almost always wise to use an interfacing in the buttonhole area. An interfacing holds the fabric firmly so that a neat buttonhole may be stitched and keeps the finished buttonhole in shape. Interfacing is essential when the fabric is loosely woven or is a crepe or knit that stretches easily.

When planning your garment, remember that both round-end and bar-tack buttonholes are stitched through three thicknesses of fabric

(garment, interfacing and facing) after the facing has been attached.

TEST SAMPLE

Always make a test buttonhole in a sample of your fabric to determine suitability of buttonhole style, buttonholing method, and machine settings. Be sure to duplicate the number of fabric layers in the garment and include interfacing if appropriate. Remember, too, that loosely woven and medium-weight fabrics require buttonholes with wider side stitching than firmly woven or lightweight fabrics. Finally, check to see that the opening for the button can be cut without damaging buttonhole stitching.

CUTTING BUTTON OPENING

Use a pair of small, sharp scissors to cut the button opening. Insert blade in center of buttonhole cutting space and cut from this point in either direction. Place a pin across the cutting space at each end of the buttonhole to protect end stitching.



Testing Buttonhole Length

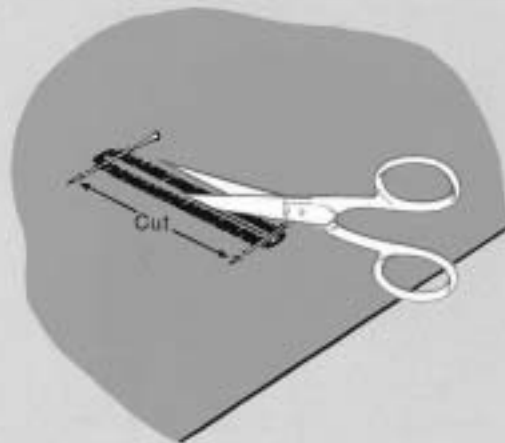

Cutting Button Opening

ROUND-END BUTTONHOLES

To stitch a buttonhole, set all dials on red symbols.

- Attach buttonhole foot
- Use general purpose throat plate

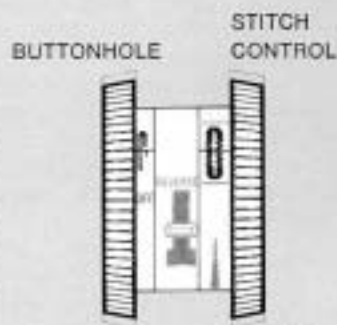
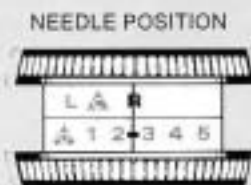
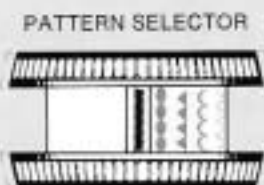

Make sure buttonhole dial is in **OFF** position when you set or reset stitch control dial on

STITCH WIDTH



Buttonhole Foot

Buttonhole Length

First, decide how long the button opening must be. This will depend on the diameter and thickness of the button as explained on page 43. Then add $\frac{1}{8}$ inch for end stitching ($\frac{1}{16}$ inch for each end of buttonhole). This end-stitching allowance is approximate and should be increased slightly if the buttonhole is to be stitched twice. Fabric thickness and thread diameter will also vary end-stitching depths, so be sure to check measurements by making a test buttonhole. Mark buttonhole position and length on fabric. See page 42 for placement information.

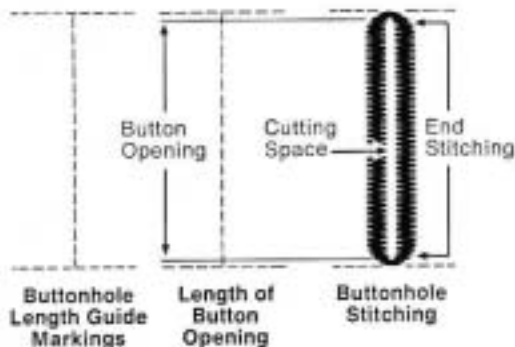

Buttonhole Stitch Width

The stitch width setting, designated by red symbol, is an approximate setting; use it to make your test buttonhole. You may need to increase or decrease stitch width slightly to suit your fabric, to arrive at more pleasing buttonhole proportions, or to change the width of the buttonhole cutting space. When making stitch width adjustments, remember that as stitch width is increased, the cutting space in the center of the buttonhole is decreased.

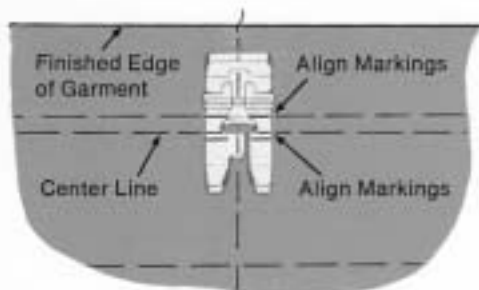

Starting Position

Procedure

- Place garment under buttonhole foot so that buttonhole position marking is centered.
- Align center gauge line of buttonhole foot with center line of garment.
- Lower the presser foot, and rotate buttonhole dial downward until symbol for step 1 is centered under red line (click indicates engagement).
- Start machine and let it complete step 1 of the buttonholing cycle; that is, stitching across the end and down the left side of buttonhole. Stop machine when front gauge line on buttonhole foot reaches end-of-buttonhole guideline on garment.
- Rotate buttonhole dial downward until symbol for step 2 is centered under red line.
- Start machine and let it complete step 2 of the buttonholing cycle; that is, stitching across the end and up the right side of buttonhole. Stop machine when back gauge line on buttonhole foot is in line with the end-of-buttonhole guideline on garment. Take one or two stitches if necessary to overlap stitching at starting point. For a smooth, satiny appearance and greater durability, stitch around the buttonhole a second time by repeating the two-step dial sequence.
- Remove work from machine, clip thread ends and cut button opening with sharp scissors.

When buttonholes are completed, reset dials for regular sewing. Make sure buttonhole dial is in **OFF** position.

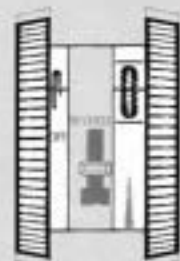

Step 1 Dial Setting

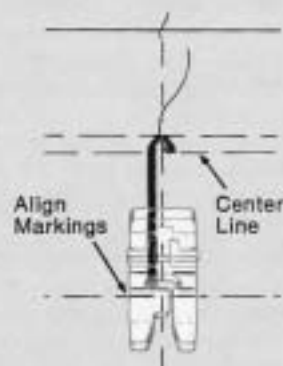

Presser Foot Position at End of Step 1

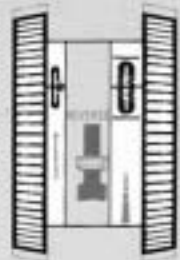

Step 2 Dial Setting

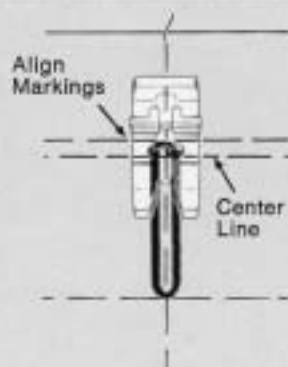

Presser Foot Position at End of Step 2

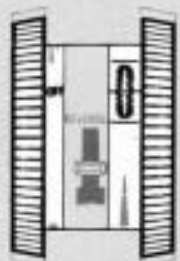

OFF Dial Position at End of Step 2

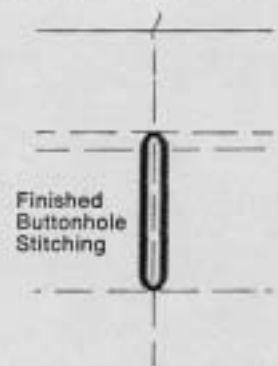

Finished Buttonhole Stitching

BAR-TACK BUTTONHOLES

- Pattern: Plain Zig-Zag
- Stitch Width: 2½ and 5 or to suit fabric
- Needle Position: L
- Stitch Control: In FINE area
- Buttonhole Dial: OFF
- General Purpose Throat Plate
- Special Purpose Foot

Bar-tack buttonholes are made in four steps by setting the stitch width dial manually for each buttonhole. You will not be using the built-in buttonholer, so be sure the buttonhole dial is set on OFF before you start to sew.

Procedure

Side stitching: Place work under needle, aligning center of buttonhole marking with center notch in special purpose foot. Set stitch width for side stitching (2½) and position needle in fabric at point A. Lower foot and stitch to end of marking. Leave needle in fabric at point B. Raise foot and pivot work on needle. Lower foot. Take one stitch without changing width setting, bringing needle to point C.

Bar tack: Set stitch width dial for bar tacks (5) and take at least six stitches. Stop at point D.

Side stitching: Reset stitch width dial for side stitching (2½). Complete work to point E.

Preparation

First, decide how long the button opening must be and add 1/16 inch for each bar tack (the closing at each end of the buttonhole). Mark fabric. Next, make a test buttonhole to determine exact stitch length and stitch width settings.

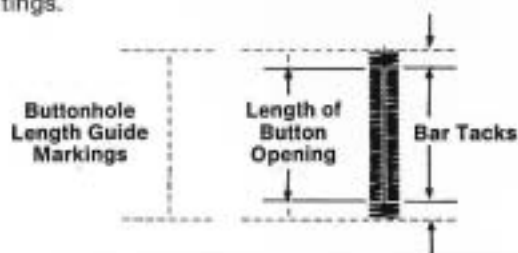

Final bar tack: Set stitch width dial for bar tacks (5), and take at least six stitches *in reverse*, ending at point F.

Fastening stitch: To secure stitching, move stitch width dial to Δ and take three stitches. Remove work, draw threads to underside, fasten and trim. Cut opening with sharp scissors.

Corded Bar-Tack Buttonholes

Corded bar-tack buttonholes are made by stitching over a cord of embroidery or crochet thread. Insert cord through the left eyelet of the special purpose foot and draw it to back of foot. Proceed as for plain bar-tack buttonholes *except*, before making final bar tack, cut cord close to eyelet.

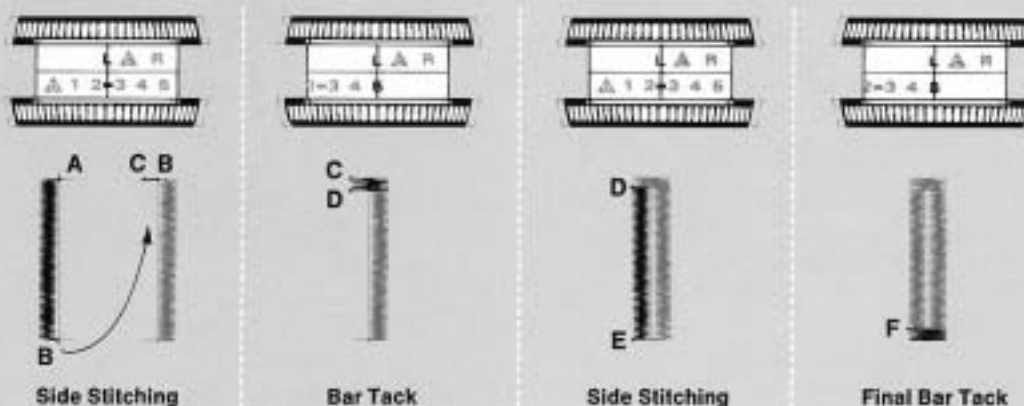

9. FREE-MOTION STITCHING

In free-motion stitching, you sew without a presser foot and control fabric movement by means of an embroidery hoop. Either a straight or a plain zig-zag stitch can be used. Because you can move the hoop in any direction — forward or backward, from side to side, or even diagonally—free-motion stitching is extremely useful for embroidery designs. On the other hand, it is equally useful for darning.

If you are **embroidering**, you can vary the length of stitches simply by moving the hoop faster or slower under the needle. The faster you move the hoop, the longer the stitches will be. You can also vary the width of zig-zag stitches from wide to narrow by controlling the angle at which the hoop is placed and moved under the needle.

For **darning**, the embroidery hoop used in free-motion stitching enables you to hold the fabric taut—a real advantage when your fabric is lightweight or soft and thus likely to pucker. See page 70 for directions.

flower embroidery

- Pattern: Plain Zig-Zag
- Stitch Width: 2 to 5
- Needle Position: 
- Feed Cover Throat Plate
- No Presser Foot
- Presser Bar: Lowered

PREPARATION

Trace design on right side of fabric. (If you have designing skill, you will enjoy creating your own patterns; otherwise, you can buy attractive transfer designs.) Place work in an embroidery hoop large enough to encompass the entire design. Be sure fabric is held taut and add an underlay if fabric is soft. Remove presser foot and replace regular throat plate with the feed cover plate.

PROCEDURE

1. Position work under needle and lower presser bar to engage tension.

2. Hold needle thread loosely and turn hand wheel toward you to bring bobbin thread up through fabric. Hold both thread ends and lower needle into fabric.
3. Stitch, outlining or filling in design with zig-zag stitches. For a smooth, satiny surface, place parallel stitches close together, moving hoop slowly and steadily. For an irregular texture, move the hoop more rapidly, allowing some stitches to overlap.

A series of bar-tacks can be used to form spray-like leaves or flowers. This technique adds variety and lightness to many designs. Leaves and petals formed in this way may carry the thread from one bar tack to the next. This carrying thread eliminates tying of the thread ends.



10. SEWING THE PROFESSIONAL WAY

construction details

ZIPPERS

At the notions counter in your Singer store, you will find many different kinds of zippers, one of which will be just right for whatever you wish to sew. How the zipper is inserted will depend on the type of garment and the location of the zipper. The zipper package will contain easy-to-follow instructions. And, if you use the zipper foot, you will find it easy to form an even line of stitching close to the zipper.

-
- Pattern: Straight Stitch
 - Stitch Width: Δ
 - Needle Position: Δ
 - Stitch Control: 10 to 15
 - General Purpose or Straight Stitch Throat Plate
 - Zipper Foot
-

Adjusting the Zipper Foot

When the zipper is to the *right* of the needle:

1. Loosen the thumb screw at the back of the foot, and slide the foot to the *left* of the needle.
2. Check the position of the foot by turning the hand wheel to lower the needle into the side notch of the foot, making sure it clears the foot.
3. Lock the foot into position by tightening the thumb screw.
4. Lower presser bar. Make sure the needle clears the foot on all sides of the notch.

When the zipper is to the *left* of the needle, adjust the foot to the *right* of the needle in the same way.

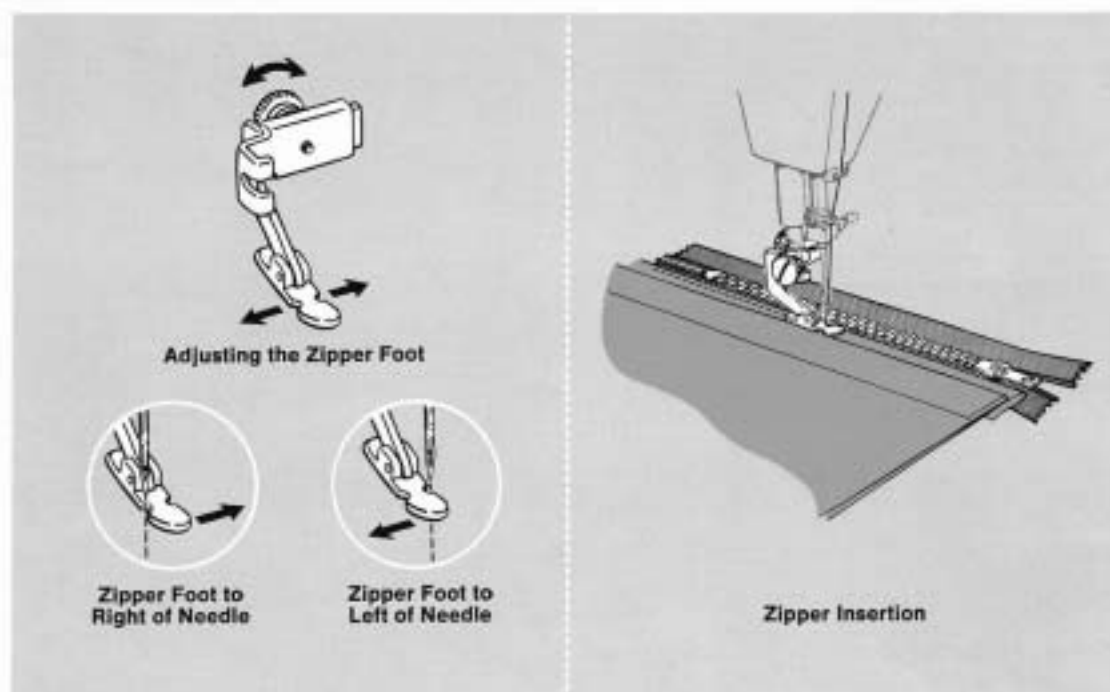

DARTS

Darts can be made in the usual way on your sewing machine. That is, you begin stitching at the wide end of the dart, stitch to the point, and then fasten the two thread ends.

However, thanks to the push-button bobbin, you can avoid the problem of fastening the thread ends by making a "continuous-thread" dart and stitching in the opposite direction. This method is particularly useful for darts in sheer fabrics, where transparency requires a neat, clean finish. It is also useful for darts made on the right side of a garment as a style detail.

Regular Darts

- Pattern: Straight Stitch 
- Stitch Width: 
- Needle Position: 
- Stitch Control: About 12 or to suit fabric
- General Purpose Throat Plate
- General Purpose or Straight Stitch Foot

1. Stitch from the seam edge, tapering gradually to the point.
2. Stitch beyond the fabric to form a thread chain $\frac{1}{2}$ to $\frac{3}{4}$ inch long. Clip thread ends about 2 inches from dart point.
3. Tie the thread ends into a single knot close to the stitching.

Continuous-Thread Darts

1. Set the machine as for regular darts.
2. Wind an empty bobbin with enough thread to make a single dart (usually less than one yard).
3. Close slide plate, and position the needle in the very edge of the fold, at the point of the basted or pinned dart.
4. Lower the presser foot.
5. Stitch carefully from the point to the wide end of the dart at the seam edge.

Remember to remove excess thread from bobbin before rewinding.



Regular Darts

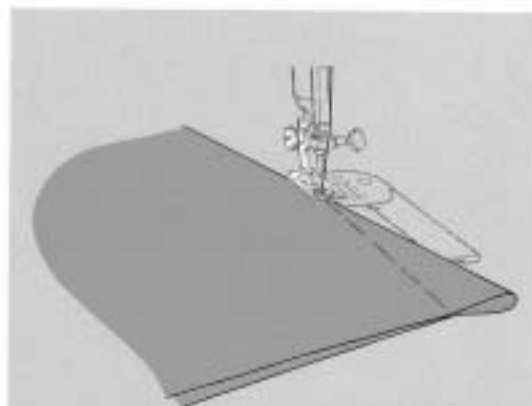

Starting to Stitch Continuous-Thread Dart

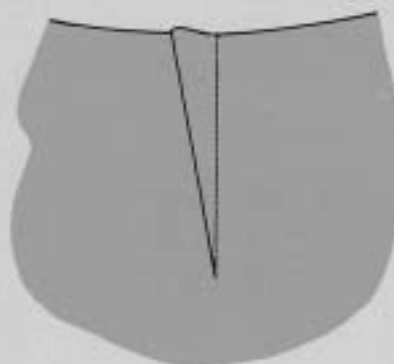

Continuous-Thread Dart

Darts in Interfacing

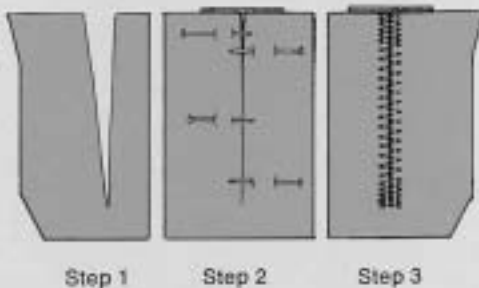

Eyelet Threading





Stitching an Inside Seam

Cutting Seam Allowance





Darts in Interfacing

- Pattern: Zig-Zag  or Multi-Stitch Zig-Zag 
- Stitch Width: 5
- Needle Position: 
- Stitch Control: About 20 or to suit fabric
- General Purpose Throat Plate
- General Purpose Foot

With zig-zag stitching, darts in interfacings can be shaped without bulk.

1. Cut out the dart allowance on the stitching line.
2. Bring raw edges together and pin or baste in position over a muslin stay.
3. Stitch, backstitching at both ends of dart for reinforcement.

INSIDE SEAMS OF SHEER COLLARS, FACINGS, AND CUFFS

- Pattern: Plain Zig-Zag 
- Stitch Width: 1 or 2
- Needle Position: 
- Stitch Control: In **FINE** area
- General Purpose Throat Plate
- Special Purpose Foot

With a delicate hairline finish, seam allowances that ordinarily show through can be eliminated. You may wish to use a filler cord to give body to the seam. For easy handling of the cord, place spool on the table, floor, or in your lap. Unwind a sufficient amount to avoid tension or strain on the cord. Lead the end of the cord through the right eyelet in the toe of the presser foot. Draw cord under cross bar to the back of the foot. Stitch along seam line, covering the cord. Cut seam allowance away close to line of stitching, turn to right side, and with thumb and forefinger, roll out curved edges. Press flat.

BLINDSTITCH HEMS

- Pattern: Blindstitch
- Stitch Width: 2 to 5
- Needle Position: 
- Stitch Control: 10 to 20
- General Purpose Throat Plate
- General Purpose Foot
- Seam and Blindstitch Hem Guide

Blindstitching provides a durable hem finish that is almost invisible. It is best suited to straight or slightly curved hems. Taped, bound, turned, or unfinished hem edges can be blindstitched with equal ease. Blindstitching takes a little practice, however, so make a test sample first.

1. Mark, turn, and press hem in the usual way.
2. Baste a guideline $\frac{1}{4}$ inch from top of hem edge.
3. With the work wrong side up, turn the hem under, creating a soft fold about $\frac{1}{4}$ inch from top of hem.

4. Place hem edge over feed of machine with bulk of fabric to the left.
5. Screw seam and hem guide into hole at right of slide plate and adjust it over the right toe of the presser foot so that it rests next to the soft fold.
6. Stitch so that straight stitches fall on hem edge and sideward stitches pierce the soft fold. While stitching, guide the fold evenly against edge of hem guide.
7. When stitching is completed, swing guide out of position before raising presser foot. Remove basting stitch.



Seam and Blindstitch Hem Guide

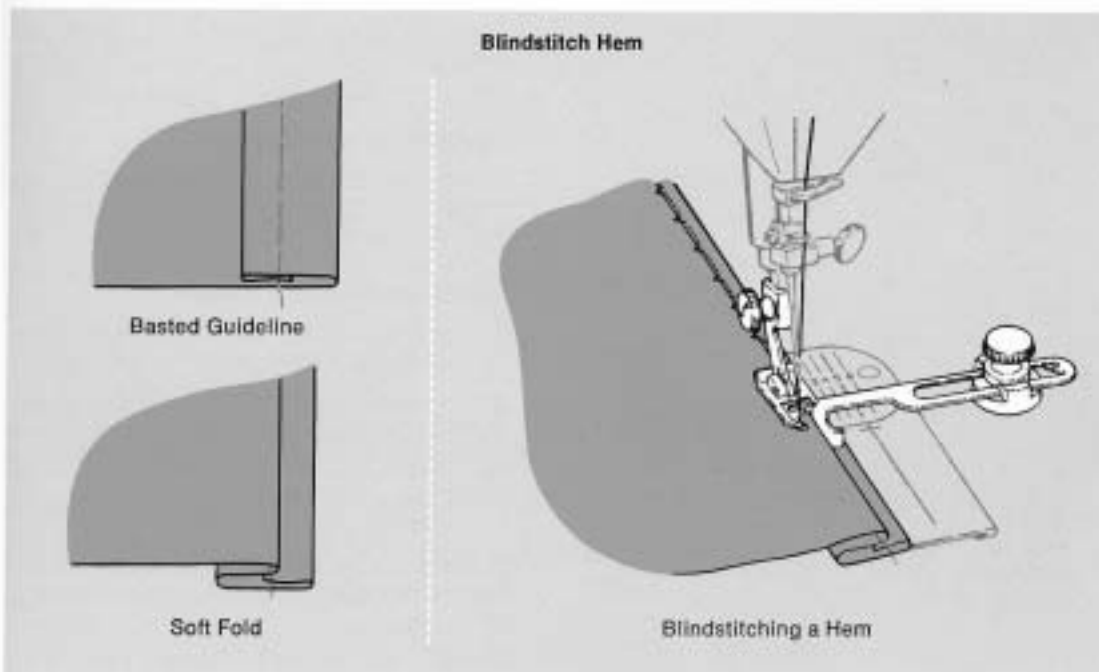

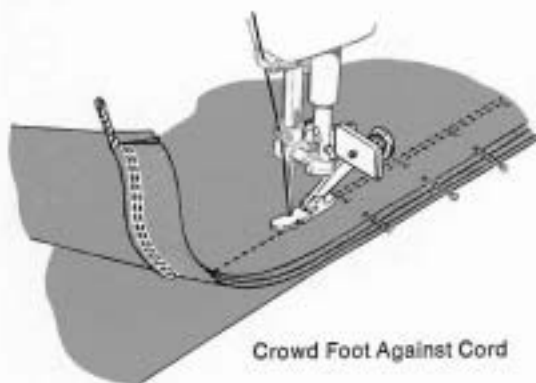
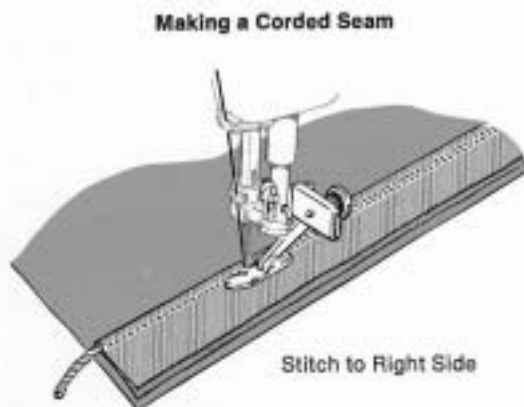
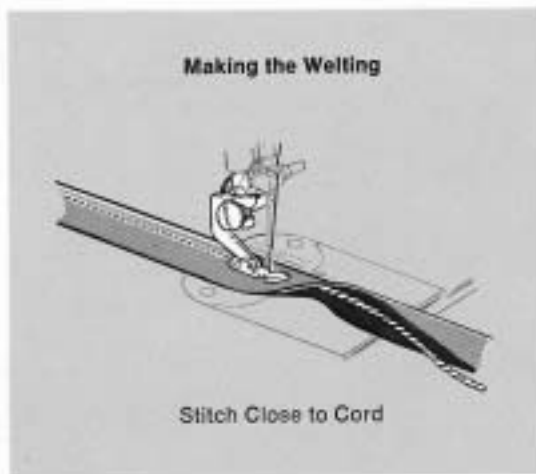

CORDED SEAMS

The corded seam is a professional treatment for slipcovers, children's clothes, blouses, and lingerie. To make a corded seam, make the welting first (or buy it ready-made at a notions counter), then stitch it into the seam.

-
- Pattern: Straight Stitch
 - Stitch Width:
 - Needle Position:
 - Stitch Control: Slightly longer than for regular seaming
 - General Purpose or Straight Stitch Throat Plate
 - Zipper Foot
-

Making the Welting

1. Buy cable cord of desired size.
2. Cut bias strips of fabric to cover cord (width: three times the diameter of the cord plus 1¼ inches).
3. If it is necessary to sew strips together to obtain desired length, join on the length-wise fabric grain.
4. Fold bias fabric strip over cord, raw edges even.
5. Adjust zipper foot to left side of needle.
6. Lower the presser foot.
7. Stitch close to cord (do not crowd stitching against cord), pulling gently on the strip, both in front and in back of the zipper foot.

Stitching Welting into Seam

1. Adjust zipper foot to the right of the needle so that the bulk of the fabric will fall to left.
2. Stitch welting to the right side of a single seam edge; guide the edge of the foot next to the cord but do not crowd.
3. Place the attached welting over the second seam edge, and pin or baste together.
4. Place the work under the needle, with the first stitching on top so that you can use it as a guide.
5. Stitch, crowding the foot against cord.

SEAMS IN FABRICS THAT RAVEL

Seam edges support the garment and should be given a durable finish if the fabric is likely to ravel. There are two methods of finishing seams in such fabrics: trimming seam edge or overedging. Make a test sample first to determine whether method #1 or method #2 best suits your fabric.

Method #1 – Trimmed Seam Finish

- Pattern: *Flexi-Stitch* Disc 55 Multi-Stretch 
Multi-Stitch Zig-Zag 
Plain Zig-Zag 
- Stitch Width: 4 or 5
- Needle Position: 
- Stitch Control:  for disc 55, or 8 to 20 depending on stitch and fabric
- Stitch Balance: Equalized for disc 55
- Speed: In **SLOW** range for disc 55
- General Purpose Throat Plate
- General Purpose Foot

1. Select stitch pattern to suit fabric.
2. Adjust stitch width (and stitch length where appropriate) to give you the most "open" stitch that will secure the fabric edge; avoid harsh, over-stitching.
3. Stitch near the edge of seam allowance; trim seam edges evenly, after stitching.

Method #2 – Overedged Seam Finish

- Pattern: 
- *Flexi-Stitch* Disc: 59
- Stitch Width: 5
- Needle Position: 
- Stitch Control: 15 through **FINE**
- Speed: In **SLOW** range
- General Purpose Throat Plate
- Overedge Foot

1. Adjust stitch length to suit fabric.
2. Trim seam edges evenly.
3. Place trimmed seam under the overedge foot and stitch so that the zig-zag stitches fall over the edge of the seam allowance.

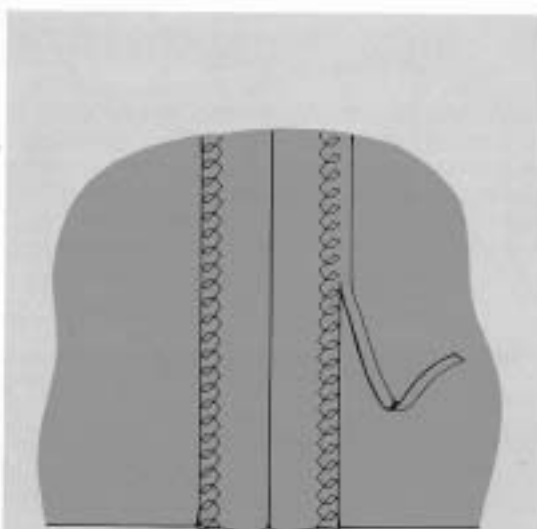

Trimming Seam Edges

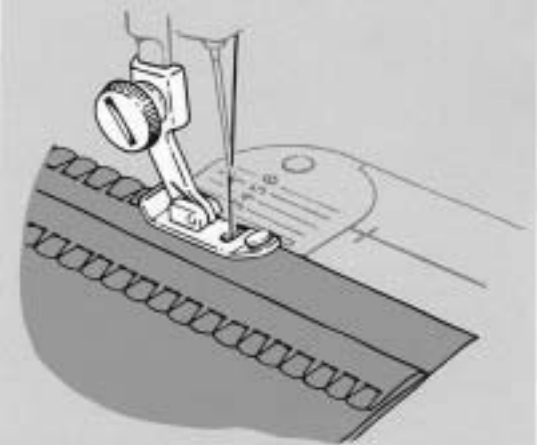

Overedged Seam Finish











sewing knit and stretch fabric

When you sew stretch fabrics, doubleknit, tricot and jersey, choose one of the stitch patterns that build stretch into the seam. A wide variety of different stitches are available (including a flexible basting stitch) so you can choose just the right one for your fabric and

sewing job. The table below will help you make the right selection.

Remember to use a ball-point (yellow band) needle in the machine when you attach elastic or sew a synthetic knit or stretch fabric.

STRETCH STITCH CHART

	Stitch	Where to Use
	Straight Stretch † <i>Flexi-Stitch Disc 51 — Stitch Width </i>	Plain seams that s-t-r-e-t-c-h (press-open or closed construction) — Crotch seaming — Sleeve and gusset insertion — Flexible top stitching — Swim and ski suit construction — Attaching patch pockets — Repairing and reinforcing seams.
	Overedge Stretch † <i>Flexi-Stitch Disc 59</i>	Overedged seams that stretch in sportswear, knitwear, slacks, bathing suits, and lingerie.
	Multi-Stretch <i>Flexi-Stitch Disc 55</i>	Overcast seams in bulky knits and terry cloth — Sweater construction — Attaching elastic and stretch lace — Seam, hem and facing edge finishes.
	Multi-Stitch Zig-Zag Built-in Pattern	Attaching elastic and stretch lace — Lingerie and swim suit construction — Girdle seams — Seam finishes — Casings and waistband finishes.
	Plain Zig-Zag Built-in Pattern	All-purpose stretch sewing — Lingerie seams — Attaching stay tapes — Seam finishing — Edge finishing — Attaching stretch lace.
	Ric-Rac Stitch † (See Combination Patterns)	Heavy-duty, all-purpose stretch sewing — Reversible top-stitch applications.
	Blindstitch Built-in Pattern	Flexible blindstitch hemming — Overcast seam finishing — Shell hems in lingerie.
	Feather Stitch † <i>Flexi-Stitch Disc 51 — Stitch Width 5</i>	Swim suit seams — Attaching stretch lace — Lingerie and girdle seams.
	Chainstitch	Flexible basting — Easy-off hem tape application.





†This stitch is designed for strength and permanence and cannot be readily ripped out without risk of fabric damage.

GUIDING AND SUPPORTING FABRIC

Most fabrics of stretch or knit construction need only to be guided in front of the presser foot when you use one of the stretch stitches. Simply let the machine move the fabric to make stitches that give *s-t-r-e-t-c-h* to seams. Some fabrics, however, require support while being stitched:

- For nylon tricot and similar synthetic knits, apply *gentle* tension by holding seam in front and back of the presser foot as you sew.
- For elasticized fabric, stretch lace, and knits with an unusual amount of elasticity, apply *firm* tension in front and back of the presser foot to stretch the seam while stitching.

OVEREDGED SEAMS

- Pattern: 
- Flexi-Stitch Disc: **59**
- Stitch Width: **5**
- Needle Position: 
- Stitch Control:  or **15** through **FINE**
- Stitch Balance: Equalized (stitch control on )
- Speed: In **SLOW** range
- General Purpose Throat Plate
- Overedge Foot

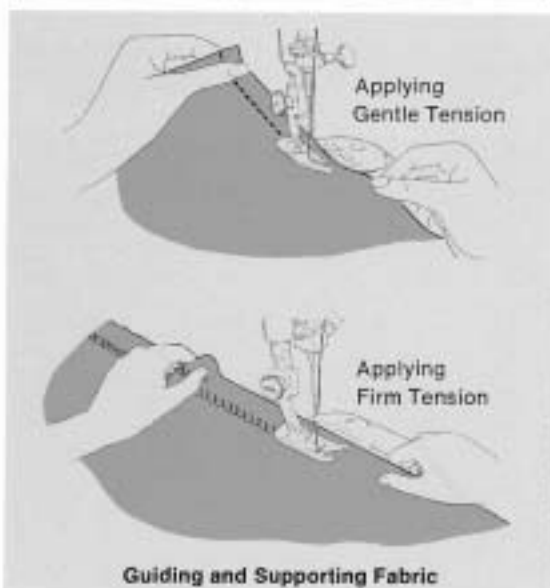

Seams in knit and stretch fabrics can be joined and finished in one operation when the overedge stretch stitch, *Flexi-Stitch Disc 59*, is used. It combines straight stitching with zig-zag overedging and is particularly useful because it can be adjusted to suit your fabric and the construction of your garment. To sew light to medium weight fabrics, set stitch control dial from **15** through **FINE**. Where extra seam strength is required, set dial on .

Procedure

1. Make a test sample before beginning garment construction to test machine adjustments. Be sure to duplicate the cut of the garment seam in your test, and use a ball point (yellow band) needle if you are sewing a synthetic knit fabric.
2. Cut and fit the garment in the regular way, using a $\frac{5}{8}$ -inch seam allowance. Baste seam line.
3. Trim seam edge evenly to a scant $\frac{1}{4}$ inch from seam-line basting.
4. Place trimmed seam under the overedge foot so that the straight stitches fall on the basted seam line and zig-zag stitches fall over the seam edge.

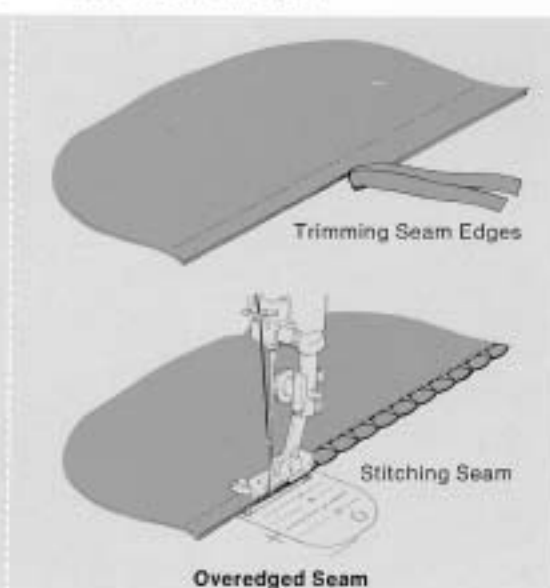

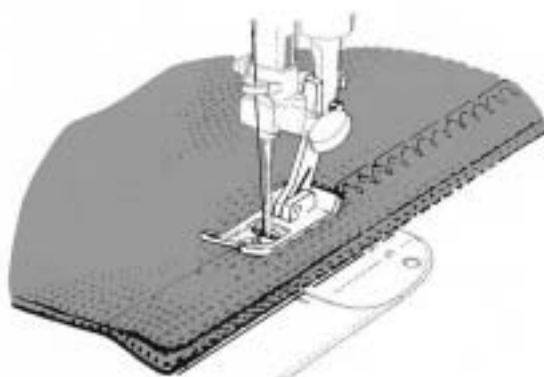

Mock Overedging

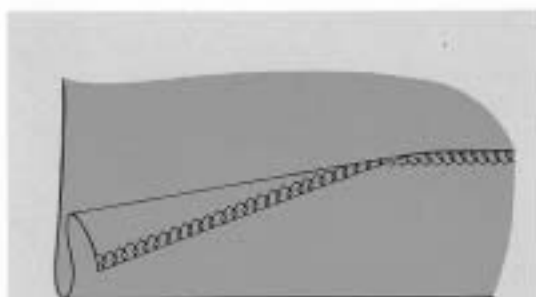

Finished Hem Edge



Applying Facing Finish

MOCK OVEREDGING

- Pattern:
- Flexi-Stitch Disc: **55** or **59**
- Stitch Width: **5**
- Needle Position:
- Stitch Control: or **15** through **FINE** for Disc **59**
- Stitch Balance: Equalized (stitch control on)
- Speed: In **SLOW** range
- General Purpose Throat Plate
- General Purpose Foot

When it is not practical to overedge a seam because of the construction of the fabric, a mock overedge finish can be applied. This finish is appropriate for bulky knits, fine tricots and fabrics that curl or fray.

Procedure:

1. Make a test sample to check machine adjustments before beginning garment construction.
2. Cut and fit the garment allowing for a $\frac{5}{8}$ -inch seam allowance. Baste seam line.
3. Place seam under presser foot and stitch so that the stitches on the left side of the pattern penetrate the basted seam line.
4. Press after stitching and trim away excess fabric to produce a narrow seam edge. When the seam supports the garment, omit the trimming step.

FINISHES FOR HEMS AND FACINGS

Hem and facing edges in knit and stretch fabrics will be less apt to press through and mark when given a flat edge-finish. Edge finishing with the multi-stretch stitch (*Flexi-Stitch* Disc **55**) eliminates the bulk of turned-in edges and retains fabric flexibility.

- Set dials as for mock overedging with *Flexi-Stitch* Disc **55**.
- Make a test sample.
- Place stitching about $\frac{1}{8}$ inch in from hem or facing edge.
- Press after stitching and trim away excess fabric close to the stitching line.

PLAIN STRETCH SEAMS

- Pattern: 
- Flexi-Stitch Disc: **51**
- Stitch Width: 
- Needle Position: 
- Stitch Control: 
- Stitch Balance: Equalized
- Speed: In **SLOW** range
- General Purpose Throat Plate
- General Purpose Foot

When you use the straight stretch stitch (produced with Flexi-Stitch Disc 51) to seam knit, stretch, and elasticized fabric, *s-t-r-e-t-c-h* and strength are built in as the seam is being sewn. Because it is equally useful for closed or press-open seam construction and will not break thread under stress, the straight stretch stitch is also good for seams that receive an unusual amount of strain when worn. For example: crotch seaming, sleeve insertion, and construction seams in sportswear and bathing suits.



Procedure:

1. Make a test sample to determine thread tension and stitch balance. Be sure to insert a ball point (yellow band) needle in machine if you are stitching a synthetic knit fabric.
2. Stitch and guide fabric as you do for plain seams stitched with the regular straight

stitch, letting the machine make the back-and-forth stitches that give *s-t-r-e-t-c-h* to the seam. If fabric has an unusual amount of elasticity, it should be stitched under tension as instructed on page 55 (Guiding and Supporting Fabric).

3. Press seam as when using the regular straight stitch.

LINGERIE SEAMS

- Pattern: Plain Zig-Zag 
- Stitch Width: **1 to 2½**
- Needle Position: 
- Stitch Control: **15 to 20**
- General Purpose Throat Plate
- General Purpose Foot

To make a lingerie seam durable and flexible, use the plain zig-zag stitch at a narrow width setting. This seam treatment is particularly suitable for bias seams. When seaming nylon tricot, insert a ball point (yellow band) needle in the machine before you begin to sew.

- Straight-stitch the seam (dials set on black  symbols) on wrong side of fabric.
- Press both seam allowances in the same direction.
- From the right side, top-stitch with narrow zig-zag stitching, letting the needle alternately enter the seam line and the seam thickness.

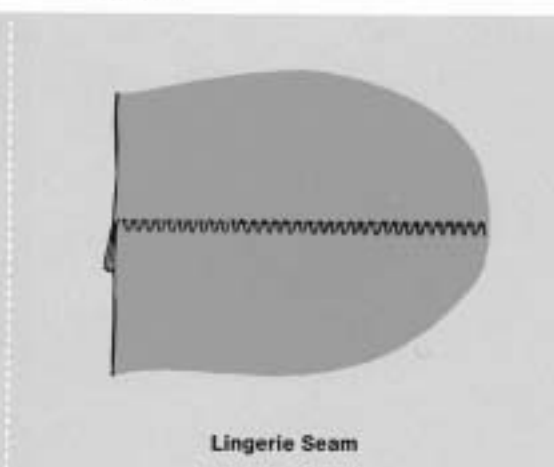
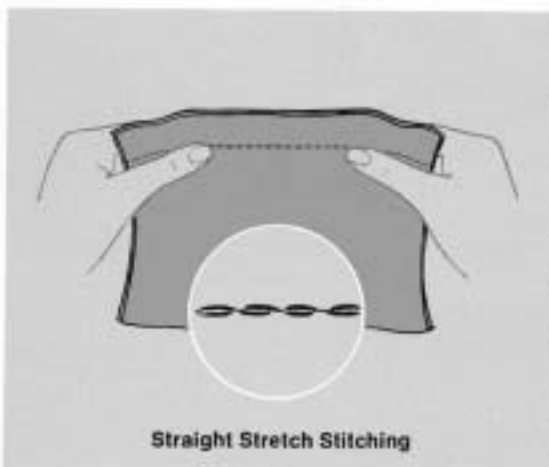

decorative touches

HEMSTITCHING

A touch of quiet elegance is added to table and bed linens when hems are finished with Paris point or Turkish hemstitching. Both types of hemstitching are effective when used on firm, plain-weave fabrics such as lawn or organdy, or fabrics from which threads can be drawn readily, such as linen.

Paris Point Hemstitching

- Pattern: 
- Flexi-Stitch Disc: **53**
- Stitch Width: **2 to 3**
- Needle Position: 
- Stitch Control: 
- Stitch Balance: Equalized
- Pressure: Light
- Speed: In **SLOW** range
- General Purpose Throat Plate
- General Purpose or Special Purpose Foot

Procedure:

1. Insert a size 18 needle (because large needle holes are desirable in hemstitching), and thread the machine with a fine cotton, silk, or synthetic sewing thread.
2. Turn edge of fabric over twice to make hem of desired width. Fold and press on lengthwise or crosswise thread of fabric. Baste in place.
3. Draw out 2 to 4 threads just above top edge of hem. The number of threads drawn will depend on the texture of the fabric and the depth of the open work desired. (If threads cannot be drawn, mark or baste a guideline on the right side of fabric.)
4. Place work, right side up, under presser foot *with the hem toward the left*.
5. Lower the presser foot and stitch, guiding the hem edge under the needle so that the straight stitches are made in the drawn-thread channel (or through the single thickness of fabric) and the sideward stitches (or points) *in the hem*.

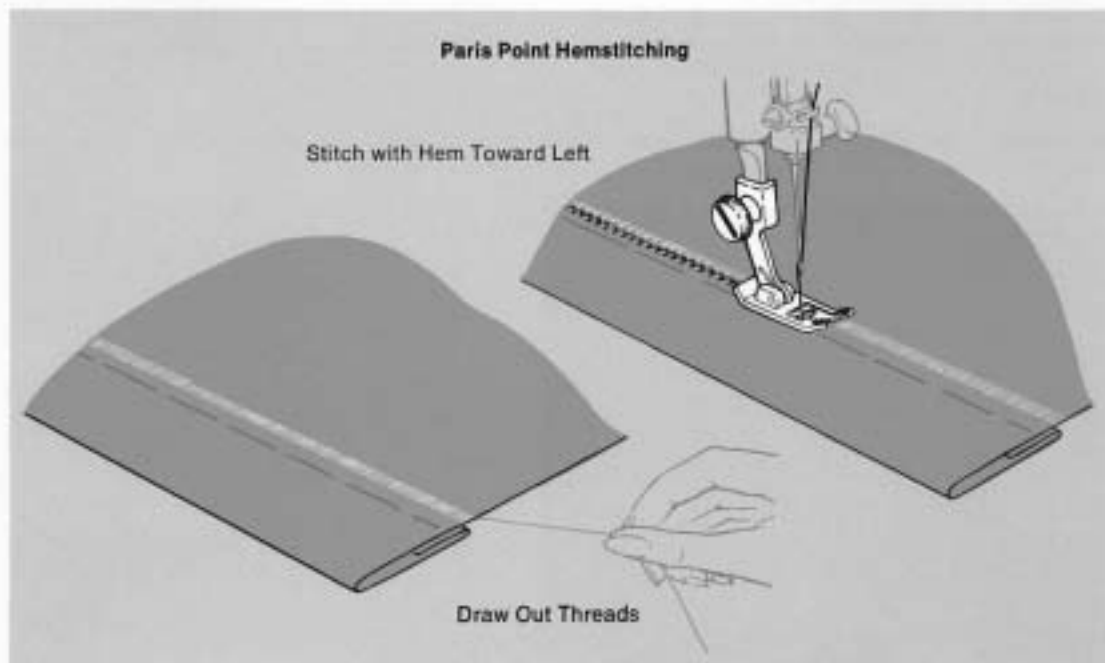

Turning a corner

Hems in household linens are usually mitered at the corners, but they may also be turned with a double overlap and stitched from edge to edge. If corners are mitered, work should be pivoted on the needle at the inside point of the miter. To pivot, leave the needle in the fabric at the corner, making sure your last stitch is a straight stitch before a zig-zag (or sideward) stitch.

Turkish Hemstitching

- Pattern: 
- Flexi-Stitch Disc: 54
- Stitch Width: 3 to 5
- Needle Position: 
- Stitch Control: 
- Stitch Balance: Equalized
- Pressure: Light
- Speed: In **SLOW** range
- General Purpose Throat Plate
- Special Purpose Foot

Procedure:

1. Insert a size 18 needle (because large needle holes are desirable in hemstitching), and thread the machine with a fine cotton, silk, or synthetic sewing thread.
2. Fold a double hem of desired width on lengthwise or crosswise thread of fabric. Baste in place.
3. Mark or baste a guideline on right side of fabric just above top edge of hem.
4. Place work, right side up, under presser foot with hem turned to the left.
5. Lower the presser foot and stitch, guiding the hem edge under the needle so that the stitches on the right side of the hemstitching are made over the hem edge (in the single thickness of fabric) and the stitches on the left side penetrate the thickness of the hem.

Corners may be turned with a double overlap, or mitered and stitched in the same manner as for Paris point hemstitching.

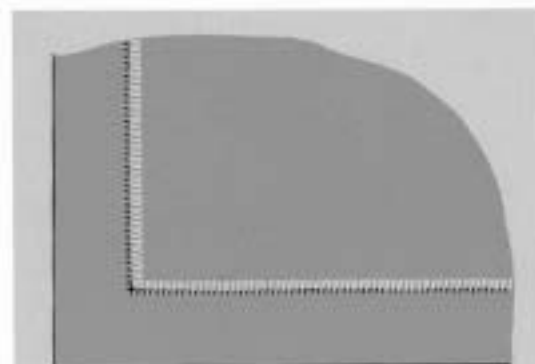

Hemstitched Corner

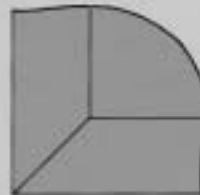

Mitered Corner

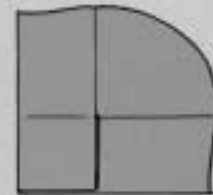

Double Overlapped Corner

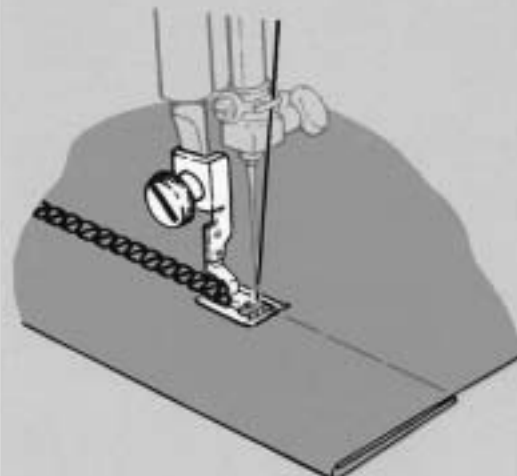

Turkish Hemstitching

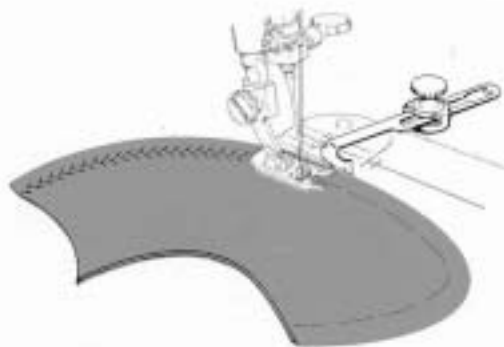

Top Stitching with Feather Stitch

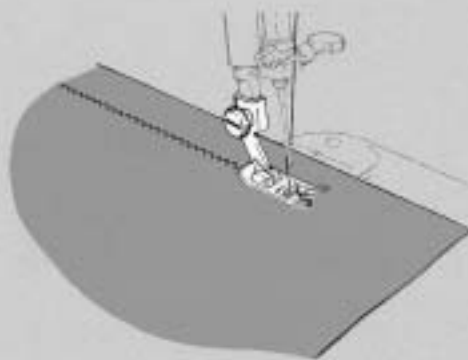

Stitching a Picot Edge

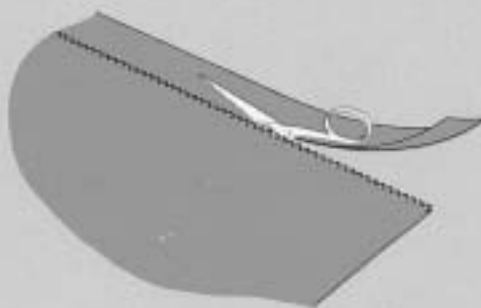

Trim Fabric Close to Stitching

TOP STITCHING

A practical, simple way to accent the lines of a dress or coat is to place one or more rows of stitching along collars, lapels, facing edges, pockets, seams, etc. For a tailored look, use lines of regular straight stitching; sew them with buttonhole twist for added emphasis. For decorative interest, use a stitch pattern. To add firmness to hems and seams in knit and stretch garments, top-stitch with the straight stretch stitch (*Flexi-Stitch Disc 51*). The seam and hem guide will help you place the rows accurately.



PICOT EDGES

-
- Pattern: 
 - *Flexi-Stitch Disc*: 53
 - Stitch Width: 2
 - Needle Position: 
 - Stitch Control: 
 - Stitch Balance: Equalized
 - Speed: In **SLOW** range
 - General Purpose Throat Plate
 - General Purpose or Special Purpose Foot
-

A dainty, picot-like edge can be made in fine, sheer fabrics by using the Paris point stitch. The fine hemstitched finish produced by this disc is appropriate for edging ruffles because it eliminates bulk. Use it, too, as a foundation stitch for hand-rolled hems; it will make bias-cut edges firm and easy to handle. Soft fabrics, such as chiffon and voile, can be given a picot edge if they are supported by a crisp fabric underlay while being stitched. Make a test sample to determine the need for an underlay, and to find the correct thread tension and stitch balance.

1. Use a large needle (size 18 is recommended) and a fine cotton thread.
2. Mark stitching line approximately $\frac{1}{2}$ inch in from raw edge of fabric. Stitch along marked line, placing fabric so that the edge to be finished is turned to the right.
3. Trim fabric close to the right side of line of stitching as shown.

SHELL EDGING



- Pattern: Blindstitch  or Flexi-Stitch Disc 59
- Stitch Width: 3 to 5
- Needle Position: 
- Stitch Control: 12 to 20
- General Purpose Throat Plate
- General Purpose Foot

On soft, fine fabrics, shell edging makes an attractive finish for narrow hems and bias folds.

1. Make a test on a sample of your fabric to find the right thread tension, stitch length, and stitch width.
2. Place folded hem or bias fold (basted, if necessary) under presser foot. Turn hem or fold toward the left when using blindstitch; toward the right when using Disc 59.
3. Stitch slowly, guiding fabric so that the sideward stitches do not pierce the folded edge.

SCALLOPING

Scalloping adds interest to blouses, dresses, lingerie, and children's clothes. Scallops will be perfect in form and evenly spaced when you use the scallop stitch, *Fashion Disc 2*.

- Pattern: 
- *Fashion Disc 2*
- Stitch Width: 3 to 5
- Needle Position: 
- Stitch Control: 10 to 15
- General Purpose Throat Plate
- General Purpose Foot

1. Place right sides of fabric together. (Shaped or bias edges should be interfaced.) Stitch scallops.
2. After stitching, trim seam allowance to $\frac{1}{8}$ inch or less.
3. Clip points of scallops with scissors and, if necessary to make points lie flat, clip along curves.
4. Turn to the right side and gently push scallops out. Press flat.

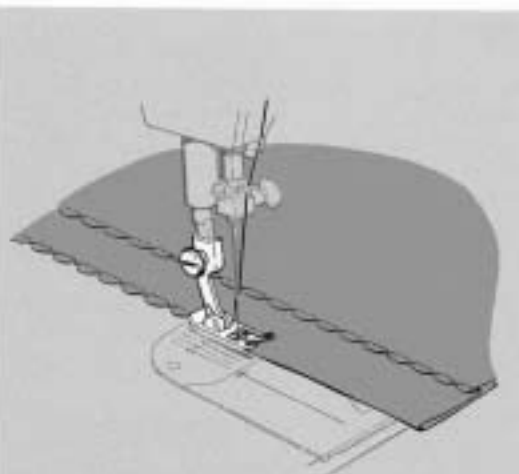

Shell Edging with the Blindstitch

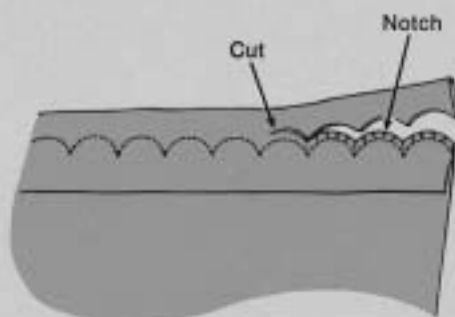

Wrong Side of Scallop



Right Side of Scallop

APPLIQUE

Applique adds beauty and interest to clothing and household linens. You can create your own design, trace a simple outline from a coloring book, or use a motif cut from a printed fabric. Fabrics of like or different texture combine equally well.

A closely spaced zig-zag stitch is most commonly used in applique work, but decorative stitch patterns may also be used effectively. Although you may vary stitch width to accommodate fabric weave or texture, never allow the stitch to be too wide.

When appliqueing, make a test sample to help you decide which of the following methods is most appropriate for your fabric and design.

Preparation

- Baste applique design to fabric.
- Outline design with straight stitching (use a short stitch).
- Remove basting and press.
- Attach special purpose foot (and general purpose throat plate).

Method #1 — Trimming after Stitching

1. Set pattern dial and stitch width dial for desired applique stitch. Adjust stitch length in the **FINE** area of the stitch control.
2. Outline the entire design with applique stitching.
3. Cut away the fabric on the outer edges of the stitching with embroidery scissors.

Method #2 — Stitching after Trimming

1. Trim outside fabric edges close to straight stitch outline of design.
2. Set pattern and stitch width dials for desired applique stitch. Adjust stitch length in the **FINE** area of the stitch control.
3. Overedge the design with applique stitching. This step will produce a smooth, lustrous finish that requires no additional trimming.

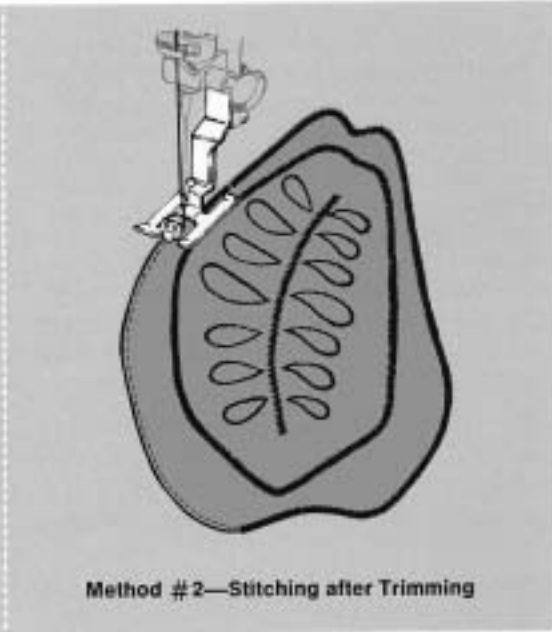
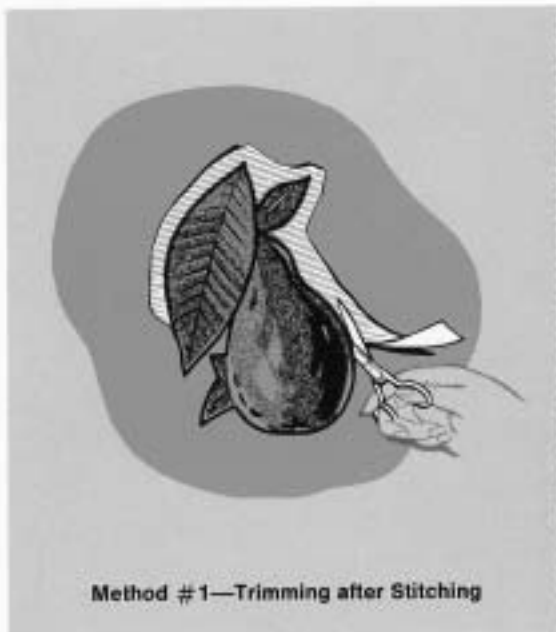

Corded Applique

Corded applique, which gives a raised, three-dimensional effect, is a particularly attractive finish for lace applique. Either method #1 or #2, previously described, may be used. Method #1 is recommended for intricate lace designs. The only change in the procedure is the introduction of a filler cord over which the applique stitch is formed.

Buttonhole twist and crochet thread make excellent filler cords. Thread them through the right eyelet of the special purpose foot as shown.

Hemstitched Applique

Designs applied with the Paris point stitch, *Flexi-Stitch Disc 53*, are particularly beautiful and especially effective on closely woven, smooth textured, and sheer fabrics when a fine thread and large needle are used to emphasize a hemstitched effect.

-
- Pattern: 
 - *Flexi-Stitch Disc*: 53
 - Stitch Width: 2 to 4
 - Needle Position: 
 - Stitch Control: 
 - Stitch Balance: Equalized
 - Speed: In **SLOW** range
 - General Purpose Throat Plate
 - Special Purpose Foot
-

1. Insert a size 18 needle and thread the machine with a fine mercerized cotton, silk, or synthetic sewing thread.
2. Follow instructions of either method #1 or method #2 for appliqueing, described on previous page.



Corded Lace Applique

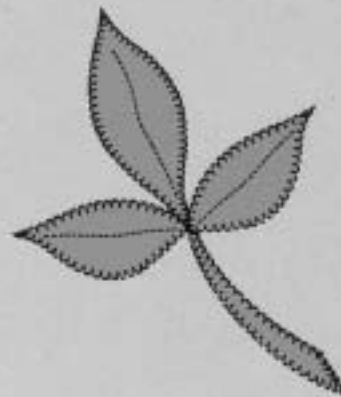

Hemstitched Applique

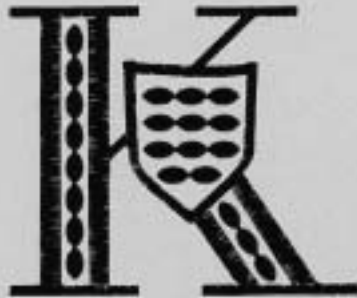

Monogram in Plain Zig-Zag and Ball Stitch



Line Monogram in Straight Stretch Stitch

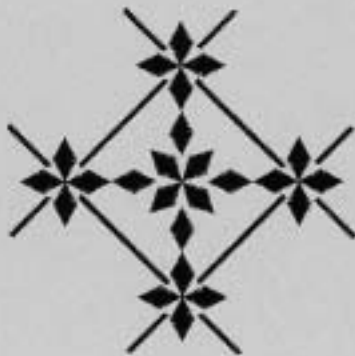

Diamond Motif

MONOGRAMS AND MOTIFS

Many decorative stitch patterns can be used for monograms and motifs — to add a personal touch to a blouse collar, for example, or for initialing household linens. You can buy designs or create them yourself to suit the stitch pattern you wish to use.

Very simple line monograms can be made with the straight stretch stitch (*Flexi-Stitch* Disc 51 at Δ stitch width), or you can create a motif by arranging individual pattern units to form a design. (Detailed information on zig-zag stitch patterns and dial settings begins on page 21.)

When you use a decorative stitch pattern to form a motif, you will want to start stitching at the beginning of the diamond, ball, or whatever pattern you have selected. For information on how to do this, turn to page 23 for built-in discs and page 26 for *Fashion Discs* and *Flexi-Stitch Discs*.



Arrowhead

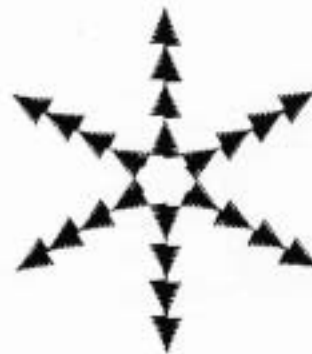

Arrowheads in Star Motif

FAGOTING

- Pattern: 
- Flexi-Stitch Disc: **51**
- Stitch Width: **5**
- Needle Position: 
- Stitch Control: 
- Stitch Balance: Equalized
- Speed: In **SLOW** range
- General Purpose Throat Plate
- General Purpose Foot

The art of joining two pieces of fabric with an open, lacy decorative stitch is called fagoting. You can create this attractive trimming with the feather stitch, *Flexi-Stitch* Disc **51**. Use it for decorative stretch seams in bathing suits or for joining together narrow strips of fabric to make an entire garment section.

- Turn under (and hem by slipstitching) the raw edges of the fabric strips or seams to be joined. Press flat.
- Stitch, guiding the two fabric edges under the center of the presser foot a scant $\frac{1}{8}$ inch apart (abut edges for bathing suit seams). Allow the needle to alternately make a stitch in each fabric strip and two stitches in the center of the opening.

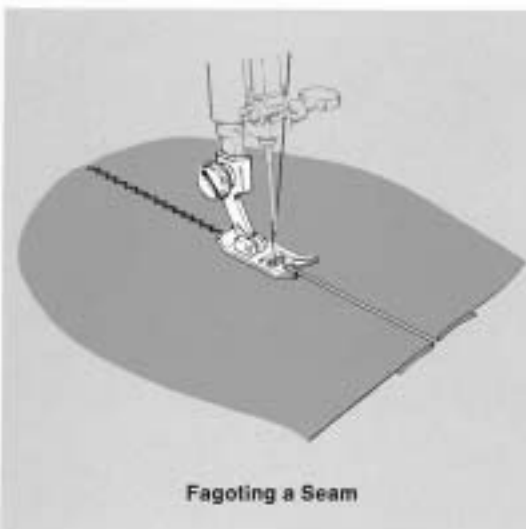

PATCHWORK QUILTING

- Pattern: 
- Flexi-Stitch Disc: **51**
- Stitch Width: **5**
- Needle Position: 
- Stitch Control: 
- Stitch Balance: Equalized
- Pressure: Light
- Speed: In **SLOW** range
- General Purpose Throat Plate
- General Purpose Foot

Patchwork for quilts and wearing apparel, formerly put together with hand stitching, can be quickly "pieced" and decorated at the same time by using the feather stitch, *Flexi-Stitch* Disc **51**. Joinings are both flexible and durable when this method is used.

Procedure:

1. Cut a fabric underlay to size. (Baste a light layer of padding to underlay if a quilted effect is desired.)
2. Prepare patches, turning under $\frac{1}{4}$ -inch seam allowance.
3. Baste patches to underlay in arrangement desired, butting all edges.
4. Stitch in lengthwise and crosswise rows, allowing stitches to straddle patches.



DRAWN-THREAD WORK

- Pattern: 
- Flexi-Stitch Disc: 53
- Stitch Width: About 2
- Needle Position: 
- Stitch Control: 
- Stitch Balance: Equalized
- Speed: in **SLOW** range
- General Purpose Throat Plate
- General Purpose or Special Purpose Foot

Drawn-thread work is a simple decorative treatment that can be used to add interest to table linens, dresses, and blouses. It is accomplished by drawing threads from plain-weave fabrics to form open-work bands and accenting the band edges with the Paris point stitch, *Flexi-Stitch Disc 53*.

Choose a linen or linen-like fabric from which threads can be easily withdrawn and use a size 18 needle and a fine sewing thread.

Procedure:

1. Draw one (or more) threads from the fabric to mark edges of open-work bands.
2. Stitch, in drawn-thread channels, placing the fabric so that the straight stitches of the Paris point stitch are made *in* the thread channel and the sideward stitches (or points) in the solid body of the fabric. If the fabric is soft, stitch through an underlay of tissue paper.
3. After stitching is completed, draw remaining threads from the fabric to form the open work between rows of stitching. Whenever stitching crosses threads that are to be drawn, cut threads close to stitching before drawing them out.

To form a fringe, draw a thread to mark fringe depth. Stitch in drawn-thread channel (with fabric edge to the right). Ravel threads between stitching and fabric edge.

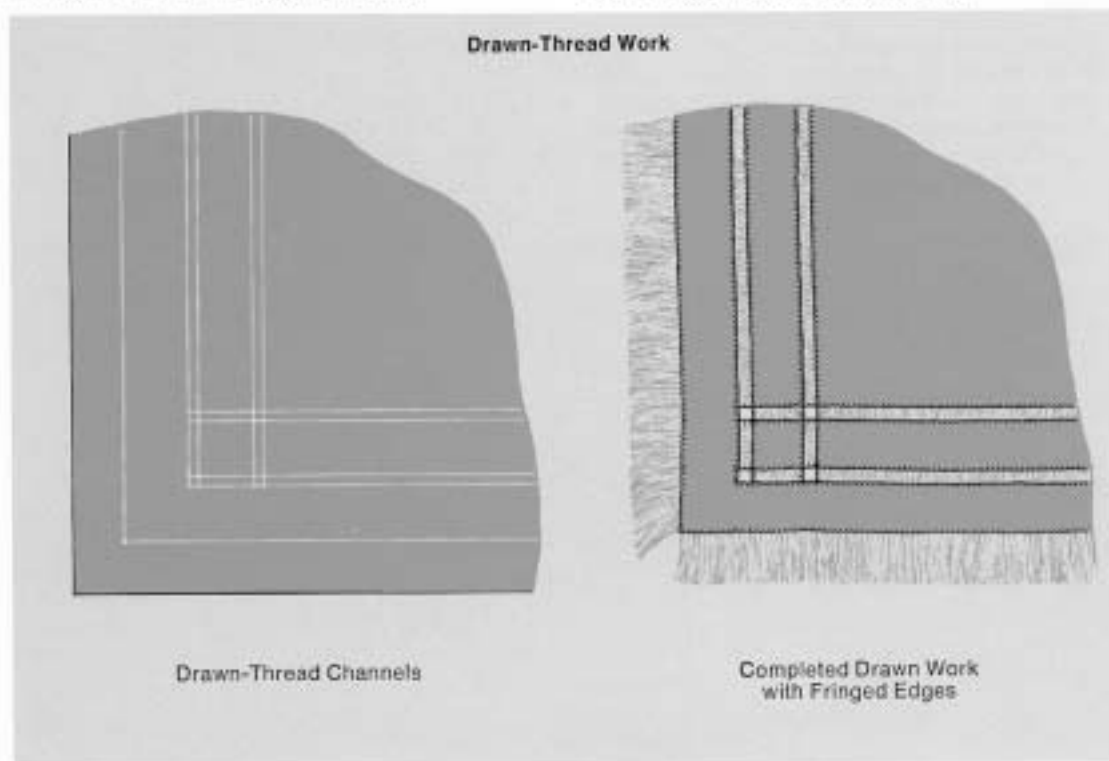

SMOCKING

Smocking is a youthful decorative detail that is particularly charming when used for a yoke, insert or band on baby clothes, little girls' dresses, or lingerie.

When worked by hand, smocking is a time-consuming process. However, the heavy-stitched look, typical of hand work, can be stitched quickly and easily with your machine when you use *Flexi-Stitch* Disc patterns.

Procedure:

1. Space rows of straight stitching, $\frac{1}{4}$ inch apart, on the crosswise fabric grain.
2. Pull up evenly for the amount of fullness desired.
3. Baste to underlay.
4. Stitch over and between rows of shirring with decorative stitching. Create your own design or adapt the one illustrated. Use thread that contrasts with or matches your fabric, depending on the effect desired.

A test sample is always advisable to check stitch settings. Be sure to use the same fabric and degree of fullness you plan for your garment.

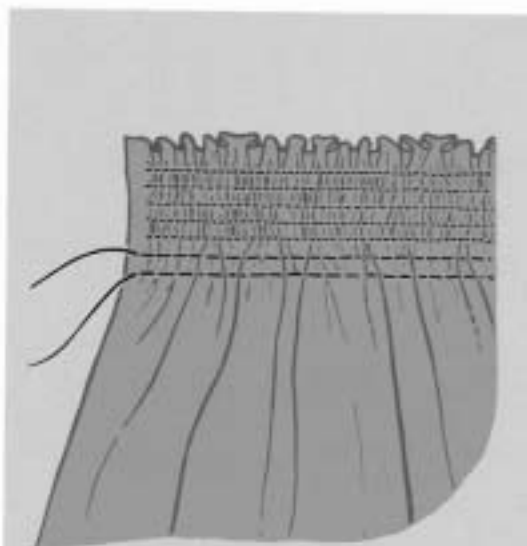

Gathering Stitches for Smocked Band

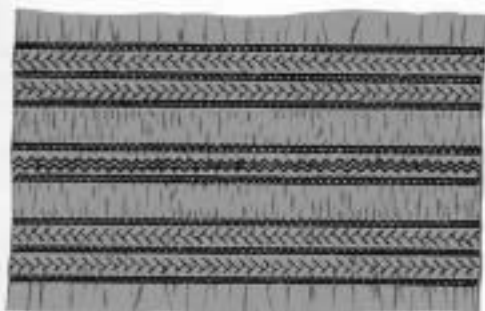

Smocked Band Accented with Cording



Smocked Band Completed

keeping up appearances

MENDING

Many zig-zag stitch patterns are just as useful for mending as they are for creative sewing. The multi-stitch zig-zag (a built-in pattern) forms a firm, flexible bond that is ideal for repairing tears and replacing elastic, while *Flexi-Stitch* Disc 55 provides a multi-stretch zig-zag

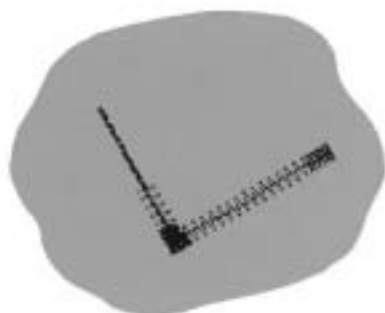

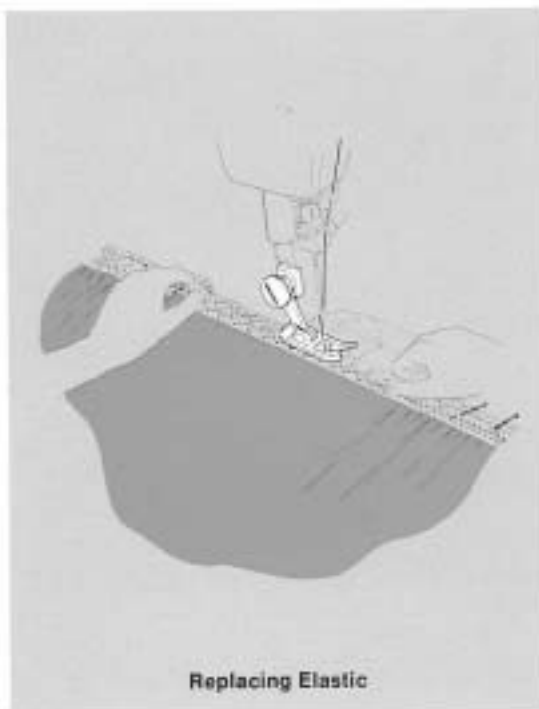

Tear Mended with Multi-Stitch Zig-Zag



Replacing Elastic

stitch for sewing stretch and elasticized garments. Stretchable straight stitches for the repair and reinforcement of press-open seams are produced when the feather stitch (*Flexi-Stitch* Disc 51) is used at  stitch width setting. Bar-tacks to reinforce points of strain are made with the plain zig-zag stitch, which is built into your machine.

Mending a Tear

-
- Pattern: Multi-Stitch Zig-Zag 
 - Stitch Width: 2 to 5
 - Needle Position: 
 - Stitch Control: 20 or to suit fabric
 - General Purpose Throat Plate
 - General Purpose Foot
-

1. Trim ragged edges.
2. Place underlay on the wrong side of tear for reinforcement. (It is best not to baste or pin the underlay since you will be bringing the edges of tear together in the next step.)
3. Stitch on the right side, bringing the edges of the tear together.
4. Shorten stitch length at ends and corners to give extra strength.
5. Trim underlay.

Replacing Elastic

When replacing waistline elastic in lingerie, use settings and accessories as for "Mending a Tear."

1. Fit elastic for desired snugness at waistline, allowing one inch for joining. Lap the ends and join with multi-stitch zig-zag.
2. Divide elastic band and garment waistline into quarters. Lap elastic over fabric and pin the two together at these intervals. Place pins at right angles to stitching line.
3. Take a few stitches to anchor elastic to fabric, then hold the elastic taut as you stitch so that it will remain stretchable after stitching is completed.

Repairing Seams

Breaks in press-open garment seams can be repaired quickly and easily when you use the feather stitch (*Flexi-Stitch* Disc 51). The reinforced straight stitch produced by this disc at Δ stitch width setting is both strong and flexible. It is ideal for knit and stretch fabrics, and particularly useful for repairing or strengthening curved seams, or seams that will receive strain when worn.

1. Make a test sample to check dial settings.
2. Remove loose thread along the break and press seam edges *together*.
3. Re-stitch along original seam line, guiding seam under presser foot without stretching fabric, letting the machine move the fabric to make the back-and-forth stitches that give *s-t-r-e-t-c-h* to the seam. Overlap stitching one inch at each end. Press seam open.

Repairing Stretch Garments

- Pattern: 
- *Flexi-Stitch* Disc: 51 or 55
- Stitch Width: 3 to 5
- Needle Position: Δ
- Stitch Control: 
- Stitch Balance: Equalized
- Speed: In **SLOW** range
- General Purpose Throat Plate
- General Purpose or Special Purpose Foot

Seams in stretch garments and lingerie retain their elasticity when stitched with the multi-stretch stitch (*Flexi-Stitch* Disc 55) or the feather stitch (*Flexi-Stitch* Disc 51). These stitch patterns build *s-t-r-e-t-c-h* into the seam as it is being sewn and are equally suitable when used to top stitch (as shown) or to over-edge. Make a test sample to check dial settings and to adjust the stitch balance.

Bar Tacks

Bar tacks, to reinforce points of strain, are made with the plain zig-zag stitch at satin length. Use them at pocket corners, to attach garters, secure shoulder straps, belt loops and zipper openings.

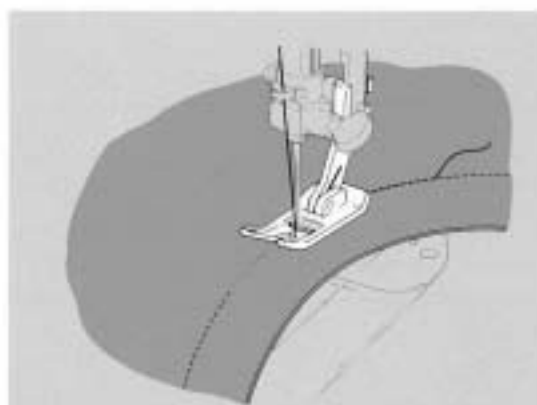

Seam Repair

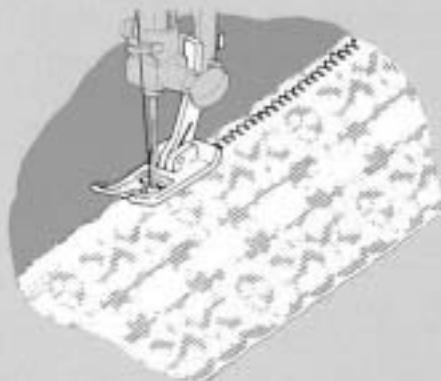

Stretch Garment Repair



Bar-Tacked Belt Loops

DARNING

Worn or torn spots on children's clothes, knits, and household linens can be darned effortlessly and quickly with little practice. You may choose to darn either with or without an embroidery hoop. When greater control is needed, an embroidery hoop is usually best.

Without Embroidery Hoop

- Pattern: Straight Stitch
- Stitch Width: 
- Needle Position: 
- Stitch Control: **10 to 15**
- Pressure: **DARN**
- General Purpose Throat Plate
- General Purpose Foot

1. If area to be darned is open, baste an underlay in place.
2. Place area to be darned under presser foot; lower presser foot and start stitching, alternately drawing fabric toward you and pulling it *gently* away from you.
3. Continue this forward and backward motion as you fill the area with parallel lines of stitching. For additional strength, cover area with crosswise lines of stitching.

With Embroidery Hoop

- Pattern: Straight Stitch
- Stitch Width: 
- Needle Position: 
- Stitch Control: In **FINE** area
- Feed Cover Throat Plate
- No presser foot
- Presser Bar: Lowered

1. Trim ragged edges from area to be darned.
2. Center worn section in embroidery hoop.
3. Position work under needle over feed cover throat plate and *lower presser bar to engage tension*.
4. Hold needle thread loosely with left hand, turn hand wheel over and draw bobbin thread up through fabric. Hold both thread ends and lower needle into fabric.
5. Outline area to be darned with running stitches for reinforcement.
6. Stitch across opening, moving hoop under needle at a slight angle from lower left to upper right. Keep lines of stitching closely spaced and even in length.
7. When opening is filled, cover area with crosswise lines of stitching.



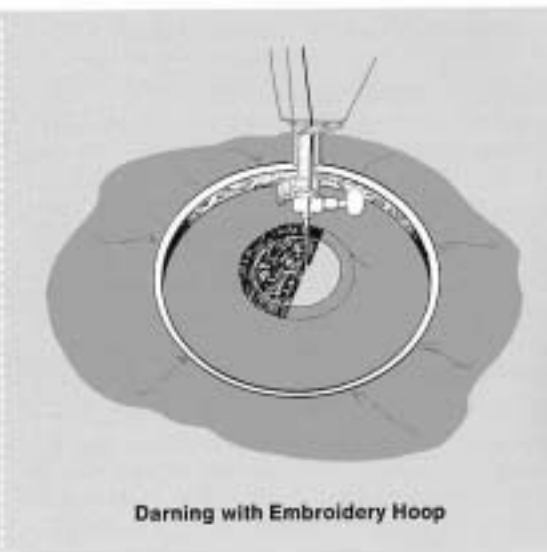

Darning without Embroidery Hoop



Darning with Embroidery Hoop

BLANKET BINDING

Often you can make an old blanket look almost new by replacing the binding. A zig-zag stitch pattern such as the plain zig-zag or multi-stitch zig-zag built into your machine may be used. The multi-stretch stitch (*Flexi-Stitch* Disc 55) is particularly suitable because it combines utility with beauty.

-
- Pattern: Setting desired (see above)
 - Stitch Width: **5**
 - Needle Position: 
 - Stitch Control:  for *Flexi-Stitch* Discs, or **15 to 20**
 - Pressure: **NORM** or less
 - General Purpose Throat Plate
 - General Purpose Foot
-

1. Make a sample first to determine correct dial settings. Reduce pressure on fabric by turning the pressure dial to a setting below normal and increase stitch length if necessary, so that blanket feeds freely. If you are using a *Flexi-Stitch* Disc, remember to equalize the design by adjusting the stitch balance.
2. Remove worn binding and baste new binding securely in place. Use hand basting or speed-baste by machine. For speed-basting instructions, turn to page 34.
3. Stitch, and remove basting.

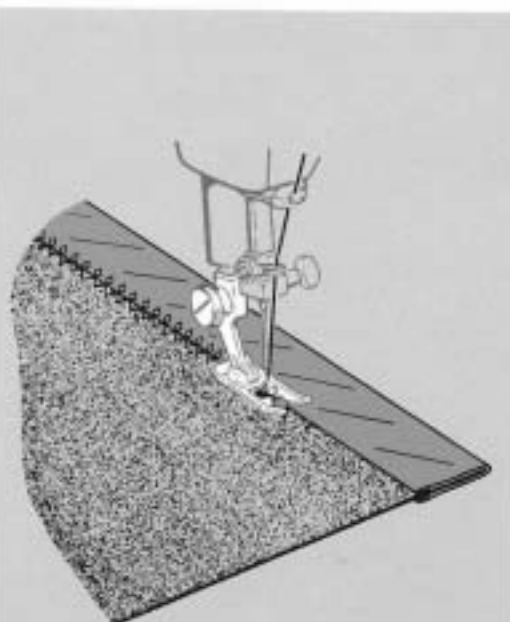

Replacing Blanket Binding

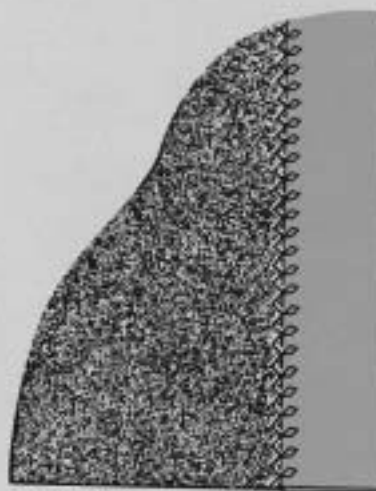

Blanket Binding Completed



Growth Tucks

GROWTH AND SHRINKAGE TUCKS

Tucks are frequently put into curtains, linings, and children's clothes to allow for the child's growth or fabric shrinkage. "Letting down" is no longer a chore when tucks are chainstitched. Simply unlock the last loop of the chain formed on the underside of the tuck and pull out the stitching. Instructions on how to set your machine for chainstitching begin on page 36.

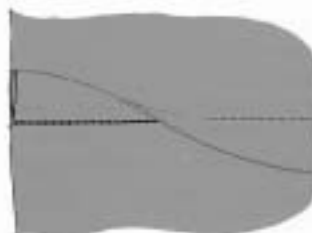

Chainstitched Tuck

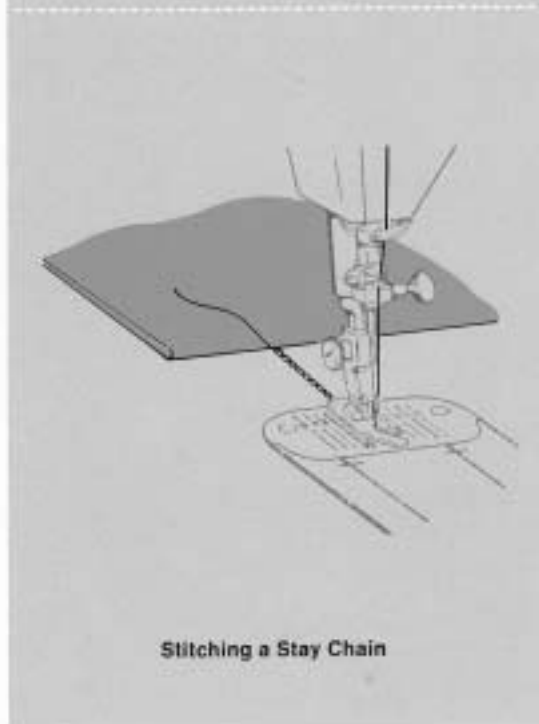

Stitching a Stay Chain

BELT CARRIERS AND STAY CHAINS

Stay chains (sometimes called French tacks) and belt loops, normally time-consuming, hand-worked finishes can now be quickly chainstitched. To produce a chain, place the first stitch in the fabric. Stitch off fabric and continue stitching until a sufficient length of chain is produced. Remove chain from machine and tack end to garment or lining with a hand sewing needle. A stitch length setting of 12 is recommended. For more information on chainstitching, turn to page 36.



Chainstitched Belt Carrier

11. CARING FOR YOUR SEWING MACHINE

cleaning the machine

Your machine will serve you perfectly for many years if you take a few moments of your time to keep it clean. How often you will need to clean the machine will depend on how often you use it.

CAUTION: Before cleaning your machine, disconnect power-line plug from electrical supply.

Remove lint or fluff from exposed parts. With a soft cloth, clean:

- Tension discs, presser bar, and needle bar
- Take-up lever and thread guides
- Bobbin case (If there is an excessive amount of lint in the area, remove the bobbin case for cleaning. See page 76 for instructions.)

- Machine surface (If necessary, dampen the cloth and use a mild soap.)

Open the face plate and, with the lint brush, clean area behind face plate.

Remove throat plate, as instructed on page 15, and, with the lint brush that comes with your machine, clean:

- Rotating hook (area under throat plate and slide plate)

After cleaning, apply only SINGER® oil at points indicated below. SINGER oil is specially prepared and does not contain harmful deposits that can interfere with the smooth action of precision parts.

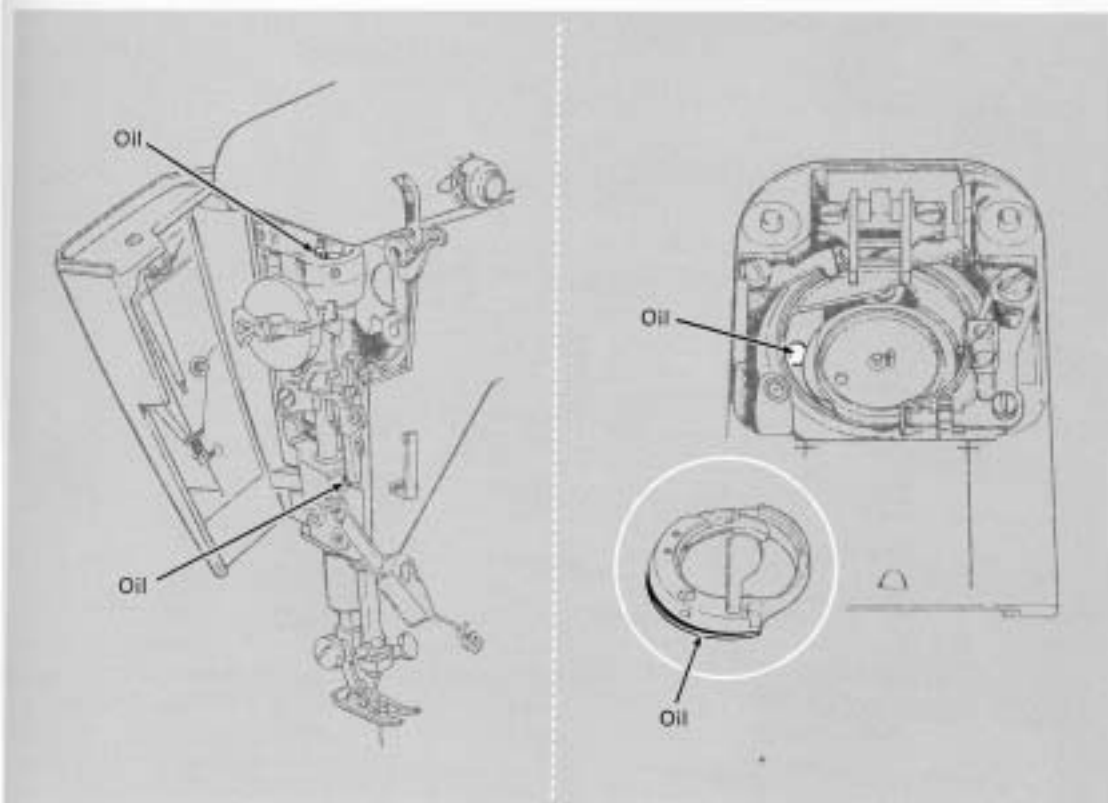

Approximately once every year, remove top and bottom covers as instructed on page 75, and clean and lubricate all moving or rotating machine connections to ensure freedom of

movement and to protect metal parts from excessive wear. To determine which connections are moving or rotating, turn hand wheel slowly (by hand) while covers are removed.

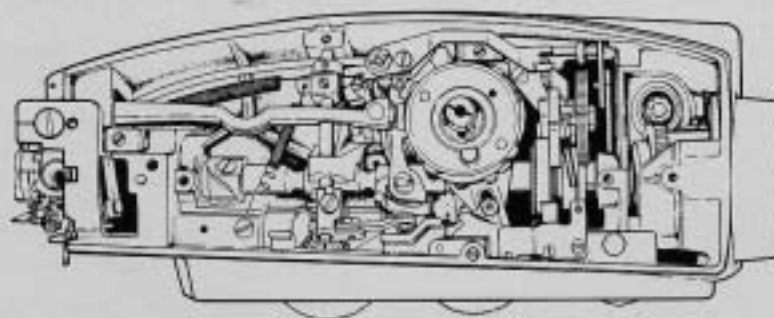

Top of Machine

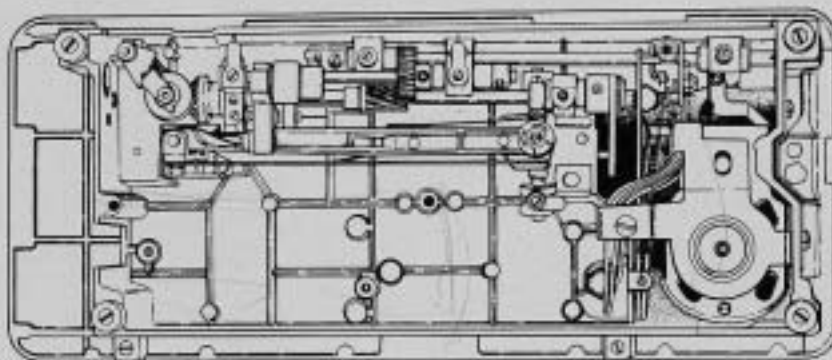

Bottom of Machine

removing covers, bobbin case, and bulb

CAUTION: Before removing covers, bobbin case, and light bulb, disconnect power-line plug from electrical supply.

REMOVING AND REPLACING TOP COVER

Move take-up lever to a low point and lower the presser foot.

1. Open stitch chart and remove screw **A**. Raise right end of top cover to clear dials and slide cover to left and off machine.
2. Replace cover by positioning it on top of arm with a *slight overhang on left side*. With right end of cover slightly raised to clear dials, slide cover to the right until it locks in place. Replace and tighten screw **A**.

REMOVING AND REPLACING BOTTOM COVER

If your machine is a portable, remove the carrying case base as instructed below.

1. Tilt machine back and remove screw in center of bottom cover. Pull cover straight up (parallel to machine bed) to remove.
2. Replace bottom cover by positioning slots in cover over the bed cushion pins at the four corners of machine. Push down on cover to snap it into place. Replace and tighten retaining screw.

REMOVING AND REPLACING CARRYING CASE BASE

1. Disconnect machine plug from electrical receptacle at right end of machine.
2. Turn machine over on its back and remove screws and washers from each end of base. Set machine and base upright, and lift machine up and out of base.
3. Replace machine in base after bottom cover has been attached. Turn machine and base over together to replace washers and screws on underside. Tighten screws.

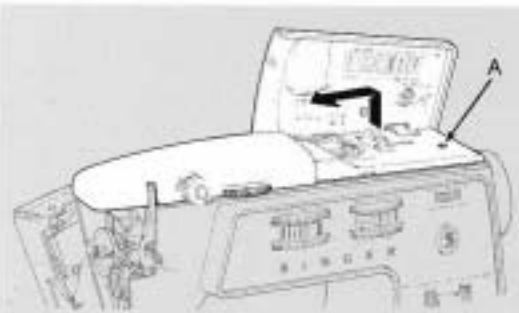

Removing and Replacing Top Cover



Removing and Replacing Bottom Cover

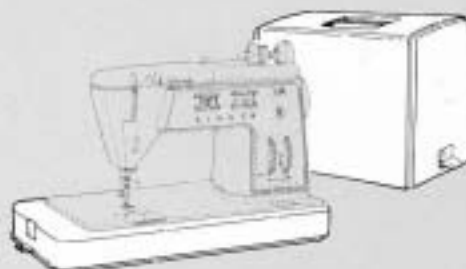

Retaining Screws and Washers



Carrying Case Base

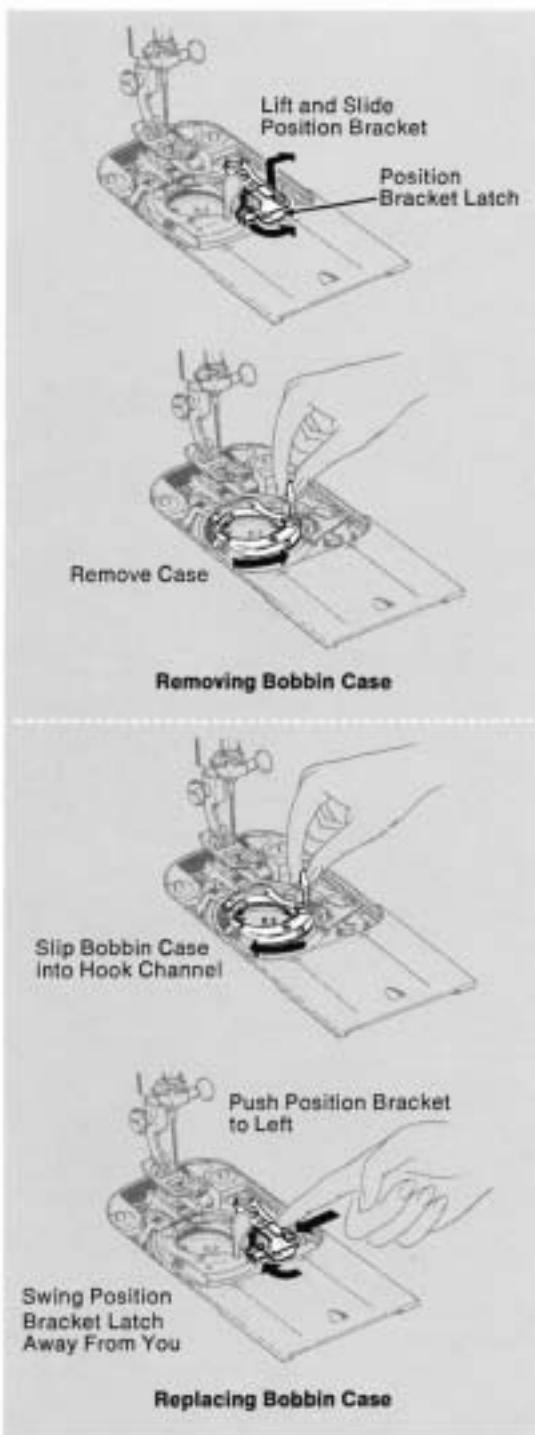

REMOVING THE BOBBIN CASE

Make sure needle is at its highest position.

1. Open slide plate and remove throat plate (see page 15 for instructions).
2. Remove bobbin. Keep bobbin push button in sewing position.
3. Swing position bracket latch toward you. Lift bracket and slide it to the right.
4. To remove bobbin case, twist case as shown, and lift out.

REPLACING THE BOBBIN CASE

Make sure needle is at its highest position.

1. Keep bobbin push button in sewing position. Hold bobbin case by latch and, with latch to right of needle, slip case in position so that the groove engages hook channel.
2. Twist bobbin case as shown, until latch is in center.
3. Push position bracket to left until it snaps down, locking bobbin case in place.
4. Swing position bracket latch away from you to lock bracket in place.
5. Replace bobbin and snap latch down.
6. Replace throat plate and close slide plate.

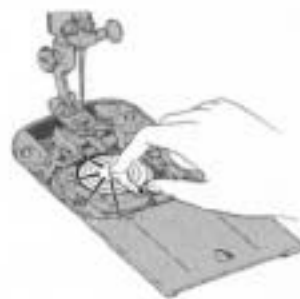

Replace Bobbin and Snap Latch Down

CHANGING THE LIGHT BULB

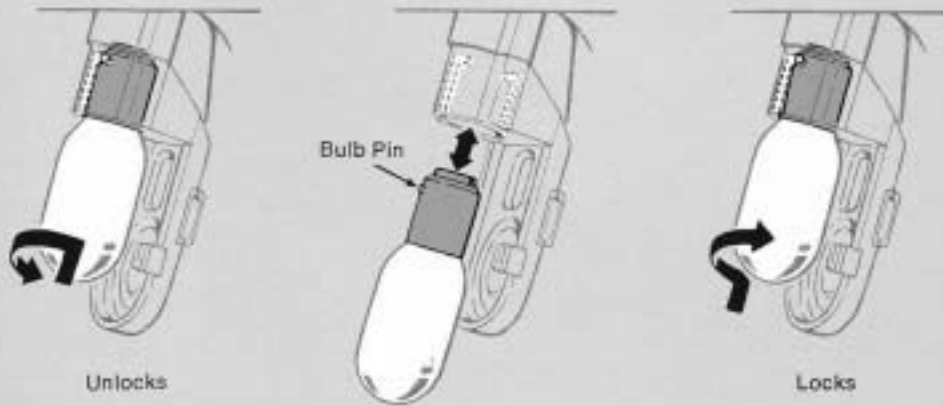

Make sure you have disconnected power-line plug from electrical outlet.

Removing Bulb. With thumb of right hand, push in and down on tab of light lens and lower the light bracket. *Do not attempt to unscrew the bulb.* Press it up into the

socket and at the same time turn bulb over in direction shown to unlock bulb pin.

Replacing Bulb. Press new bulb into socket, with bulb pin entering slot of socket, and turn it over in direction shown to lock bulb in position. Push entire assembly up until it snaps in position.

REPLACING THE SLIDE PLATE

You will not have any occasion to remove the slide plate. However, if it should accidentally become disengaged from the machine, it is easily replaced.

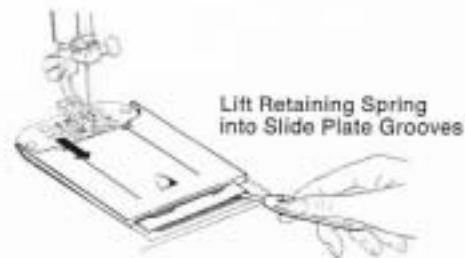
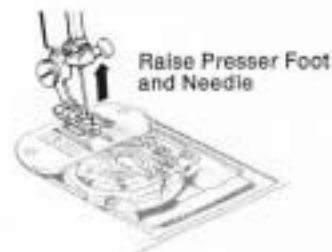

- Raise the presser foot and make sure needle is in its highest position.
- Place slide plate in slide way with the front edge close to, but not covering, the retaining spring (as shown).
- With a small screwdriver, lift each end of the spring into each of the side grooves on the underside of the plate.
- Draw the plate gently toward you and fully engage the spring.
- Close slide plate.



Replacing the Slide Plate

performance checklist

REMEMBER TO

- Turn on power and light switch.
- Turn buttonhole dial to **OFF** position before setting pattern dial, needle position dial, or stitch width dial for any purpose.
- Remove all thread from bobbin before rewinding.
- Fill empty bobbin
 - ... in center needle position .
 - ... before attaching accessories.
 - ... before inserting twin needle.
- Close slide plate after winding bobbin.
- Make sure needle is out of fabric or above throat plate before turning dials.
- Make sure stitch width does not exceed the number **2** setting when a twin needle is used.
- Use a ball point (yellow band) needle to attach elastic and sew nylon tricot, synthetic doubleknits, and spandex.
- Use high-lift presser bar setting to place heavy fabric under presser foot.
- Turn dials away from  and **MIX** settings and press disc-release lever down to change stitch pattern discs.

IF THREAD BREAKS

- Is the machine properly threaded?
- Is spool holder pressed firmly against thread spool?
- Is the needle securely tightened in the needle clamp?
- Is the needle straight?
- Is the thread suitable for the size of needle and free of knots and slubs?
- Is the thread unwinding freely from the spool?
- Is the needle-thread tension too tight?
- Is presser foot raised for bobbin winding?
- Is a moderate speed used for bobbin winding?
- Are the bobbin halves evenly and securely screwed together?
- Is the bobbin properly seated and secured by the latch in the bobbin case?
- Is the bobbin-case area free of lint and loose thread ends?

Enjoy Sewing!

If you have any questions, please write to:
Department of Sewing Education
The Singer Company
30 Rockefeller Plaza, New York, N.Y. 10020

12. FASHION AIDS

special accessories for special jobs

Fashion Aids have been designed to increase the versatility of your sewing machine and enable you to give your sewing that extra professional touch. The ones described below are just a few of the complete selection available at your local Singer store.

Professional* Buttonholer No. 102991

The *Professional Buttonholer* sews six kinds of buttonholes, plus eyelets, in a wide variety of fabrics. You choose the style and length and make perfect buttonholes every time.

Monogrammer No. 171256

With the monogrammer, you can stitch $\frac{3}{8}$ -inch-high initials to form monograms or names that add a charming individual touch to handkerchiefs, blouse collars, ties, etc.

Deluxe Monogrammer No. 171276

With the deluxe monogrammer you will have the pleasure of stitching initials $1\frac{1}{2}$ inches high to create monograms that are ideal for adding a personal touch to table linens, towels, and wearing apparel. An attractive flower motif can also be made.

Quilting Foot No. 160691

The quilting foot is especially well adapted to stitching lightly padded fabrics. It is excellent for the placement of straight stitching in block, floral, or scroll designs. This short, open foot permits following curved lines with ease and accuracy.

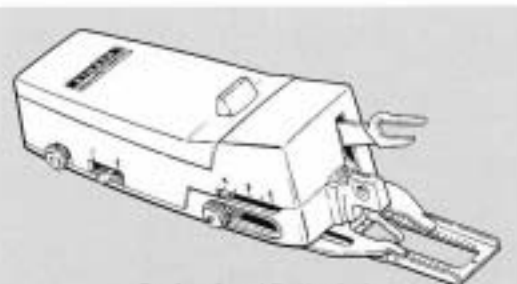

Professional Buttonholer

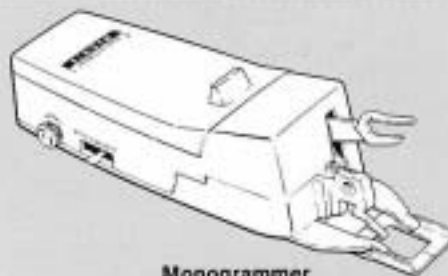

Monogrammer

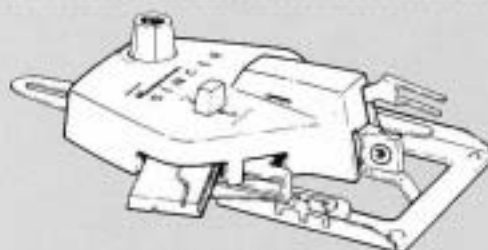

Deluxe Monogrammer



Quilting Foot



Gathering Foot

Gathering Foot

No. 161169

The gathering foot can be used for evenly spaced shirring as well as for a single line of gathering. This foot is used for straight stitching only.

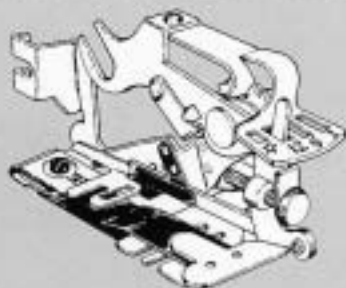

Ruffler

Ruffler

No. 161561

This accessory offers a simple, effective way to make gathered and pleated ruffles. The ruffler is used for straight stitching only.

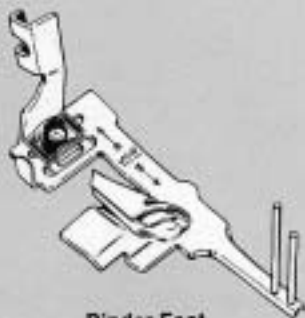

Binder Foot

Binder Foot

No. 81200

The binder foot is used to apply ready-made bias tape or unfolded bias binding to an unfinished edge. It can also be useful for binding seam edges that might ravel.

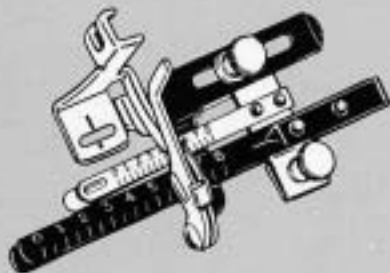

Tucker

Tucker

No. 161226

Tucks up to one inch can be stitched and marked in one operation by using the tucker. Two adjustable scales are provided to gauge tuck width and spacing.

Darning and Embroidery Foot No. 161875

This foot is recommended for all types of free-motion work. It is ideal for embroidery, monogramming, and decorative designs because the transparent toe fully reveals the line of the design to be followed.

Finger Guard

No. 161681

The finger guard provides extra safety by protecting fingers from the needle. It is ideal for the student, beginner, or the blind person. A permanently mounted, swing-away type, No. 22563, is available on special order.

Hemmer Foot

No. 161195

Narrow hems can be turned and stitched in a single operation if you use the hemmer foot. Thus, you can eliminate basting or pinning whenever you are making ruffle edges, lingerie finishes, and the like.

Edge Stitcher

No. 160625

This accessory, used with the straight stitch setting, is ideal for the joining and inserting of lace, tucking from pin width up to 1/4 inch, French seaming and seam piping, facing, and seam finishing.

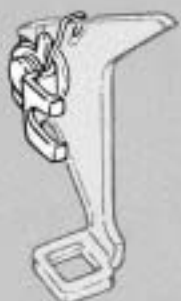

Darning and Embroidery Foot

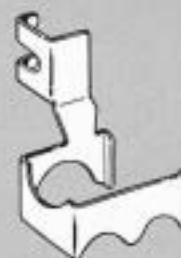

Finger Guard



Hemmer Foot

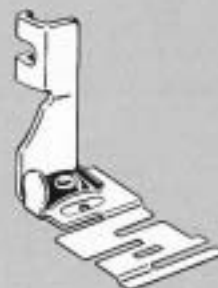

Edge Stitcher

INDEX

Accessories	2	General Purpose Foot	3, 12
Adjusting Machine to Fabric	11	Overedge Foot	3, 13, 53, 55
Applique	62	Special Purpose Foot	3, 13
Basting	18, 34	Straight Stitch Foot	3, 13
Pin	18	Zipper Foot	3, 13, 48
Speed Basting by Machine	34	Presser Foot Lifter	18
Belt Carriers and Stay Chains	72	Pressure Adjustment	1, 16
Blanket Binding	71	Principal Parts	1
Blindstitch Hems	51	Reverse Stitching	1, 20
Bobbin	7	Satin Stitching	24
Raising Bobbin Thread	10	Scalloping	61
Removing Bobbin	9	Seam and Hem Guide	2, 19
Removing Thread	9	Seams	18
Replacing an Empty Bobbin	9	Chainstitch	38
Replacing a Wound Bobbin	10	Corded	52
Winding	7	Curved	20
Bobbin Case	76	Inside	50
Built-in Discs	21	In Fabrics that Ravel	53
Buttonhole Dial	1, 45	Lingerie	57
Buttonholes	42	Straight	19
Bar-Tack	46	Sewing Knit and Stretch Fabric	54
Corded	46	Shell Edging	61
Round-End	44	Slide Plate	77
Buttons	41	Smocking	67
Caring for Your Sewing Machine	73	Spool Pin	2, 31
Chainstitching	36	Stitch Balance Dial	1, 17, 29
Choosing Fittings	12	Stitch Control Dial	1, 17, 23, 29
Choosing Needle and Thread	11	Stitch Pattern Dial	1, 22, 27
Darning	70	Stitch Width Dial	1, 23
Darts	49	Straight Stitching	18
Drawn-Thread Work	66	Curved Seams	20
Fabric, Thread, and Needle Table	11	Straight Seams	19
Fagoting	65	Turning a Square Corner	19
Fashion Aids	79	With a Twin Needle	32
Fashion Discs	25	Temporary Stitching	34
Changing Discs	26	Chainstitching	36
Flexi-Stitch Discs	27	Speed Basting	34
Floral Designs	47	Tension Adjustment	1, 16, 23, 28
Free-Motion Stitching	47	For Zig-Zag Satin Stitching	24
Growth and Shrinkage Tucks	72	Throat Plates	3, 15
Guiding and Supporting Fabric	55	Chainstitch	3, 15, 37
Hemstitching	58	Changing Throat Plate	15
How to Start Sewing	8	Feed Cover Plate	3, 15, 41, 47
Light Bulb	77	General Purpose	3, 15
Mending	68	Straight Stitch	3, 15
Monograms and Motifs	64	Top Stitching	60
Needle	2, 12	Twin-Needle Stitching	31
Position	1, 22, 28	Decorative Stitching	33
Replacement	12	Straight Stitching	32
Threader	6	Threading the Needle	31
Threading	5	Turning a Square Corner	33
Patchwork Quilting	65	Zig-Zag Stitching	32
Performance Checklist	78	Zig-Zag Stitching	21
Picot Edges	60	Built-in Disc Patterns	21
Power and Light Switch	4	Combination Patterns	30
Presser Feet	3, 12	Fashion Disc Patterns	25
Bulson Foot	3, 13, 41	Flexi-Stitch Disc Patterns	27
Buttonhole Foot	3, 13, 44	With a Twin Needle	32
Changing Presser Feet	14	Zipper Insertion	48

SINGER

GUARANTEE

WE GUARANTEE that each SINGER* sewing machine has been carefully manufactured and is in perfect operating condition on delivery. When subject to normal family use and care, any parts requiring replacement at any time owing to defects in material or workmanship will be replaced without charge.

THIS GUARANTEE does not apply to parts requiring replacement owing to natural wear or to abuse or negligence of the user or in the event the machine is serviced by other than a SINGER representative or Approved Dealer or with parts other than those supplied by The Singer Company.

IN ADDITION to the above guarantee of parts, each machine will be inspected and adjusted whenever necessary without charge for labor for a period of one year from date of purchase.

THIS GUARANTEE is effective only with respect to the person making the purchase from The Singer Company or one of its Approved Dealers. The original Sales Agreement, or Cash Receipt, must be presented to obtain the benefits of the guarantee.

AGREEMENTS inconsistent with the foregoing shall be void and of no effect.

THE SINGER COMPANY

SINGER* Service is always close at hand. If your machine should need servicing, call your local Singer store to be sure of warranted SINGER Parts and Service. You will find the address under THE SINGER COMPANY in the telephone directory.