

How to Use

Greist

ATTACHMENTS

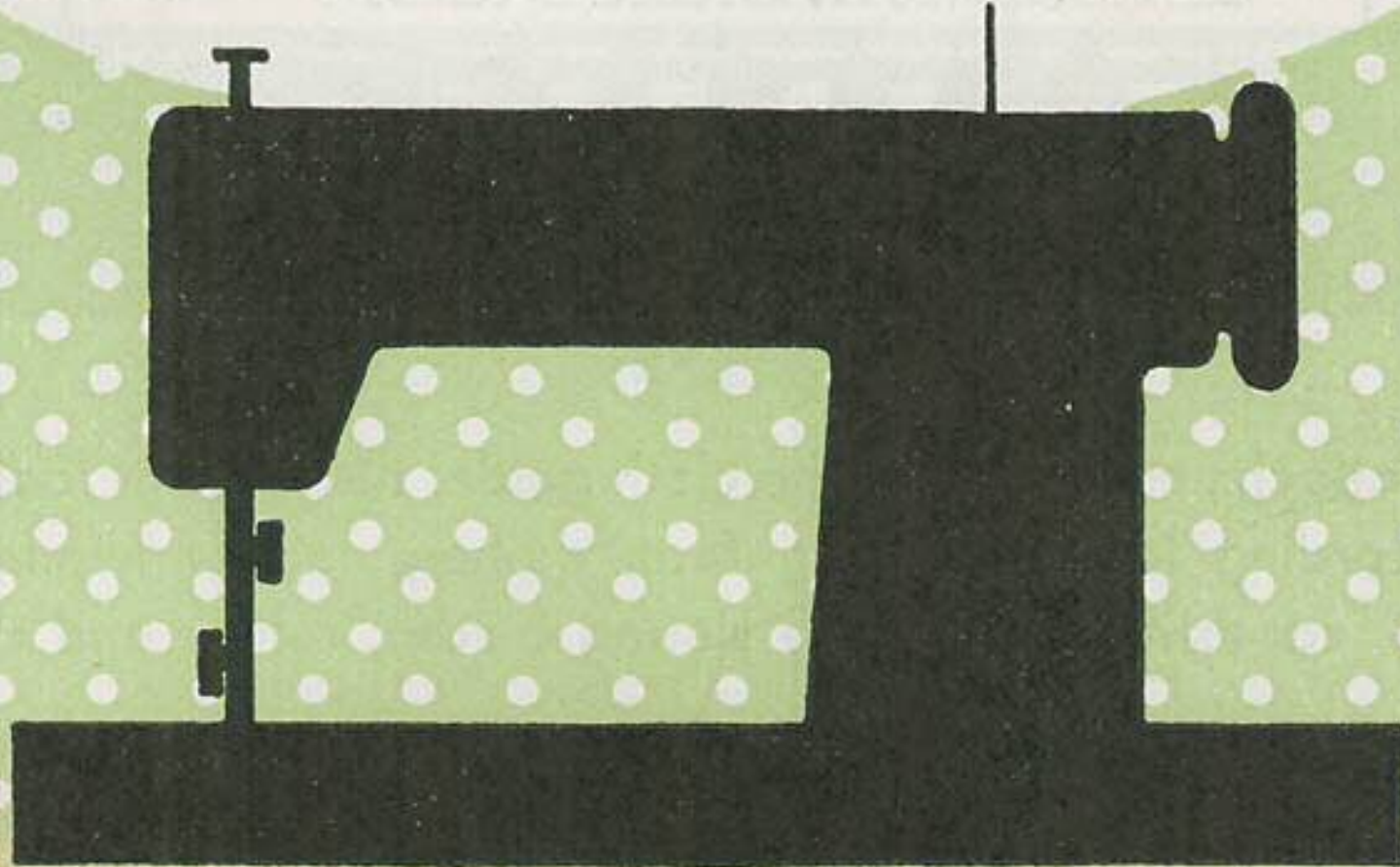



This set of attachments includes the cloth guide, attachment foot, adjustable zipper and cording foot, gathering foot, quilter, narrow hemmer, hemmer (1/4 inch hem), edgestitcher, multiple slotted binder, ruffler and stiletto.

Copyright 1957 by The Greist Manufacturing Company, New Haven 15, Conn.

6-59

Form 704-R
PRINTED
IN
U.S.A.

Contents

	Page
Fun with Attachments	2
Helpful Suggestions	3
The Cloth Guide	5
The Attachment Foot	6
The Adjustable Zipper and Cording Foot	7
The Gathering Foot	10
The Quilter	12
The Narrow Hemmer	14
The Hemmer (1/4 inch hem)	18
The Edgestitcher	20
The Multiple Slotted Binder	23
The Ruffler	26

Fun with Attachments

Not only can attachments be fun to use, but they also enable you to have that satisfied feeling of creating something lovely. They can transform a plain material into a pretty decorative one. They can change a plain design into a chic, smart one. They can give a professional look to a home-made garment. And they can do all of these things quickly and easily. It just takes a little time and patience to learn how the attachments work.

So don't wait another minute before beginning to learn all you can about your sewing machine attachments. Ruffles and pleats appear like magic. Edges are hemmed or bound quickly. Lace is applied with ease. The fascinating results seem endless. Not only can they be used on dainty things, but also on the sturdy and practical. Once you begin to use your attachments, your sewing will become more interesting and fun to do.



Helpful Suggestions

Before beginning to use your attachments, you will find it helpful to consider these bits of general information. When you are replacing the regular presser foot with an attachment, be sure that the presser bar is up and that the needle is at its highest point. Always tighten the thumb screw securely after the attachment is in place. Sometimes the vibration of the machine loosens the screw, allowing the attachment to wiggle out of position. When this happens, you may break a needle. In order to avoid this situation, check the position of this screw frequently.

After you have threaded your machine correctly, place both the upper and bobbin threads under and in back of the attachment to avoid the tangling of your threads. Be careful never to place your fingers under the attachment. Use your scissors instead.

Test the tension and the length of your stitch on a scrap of the fabric that you are

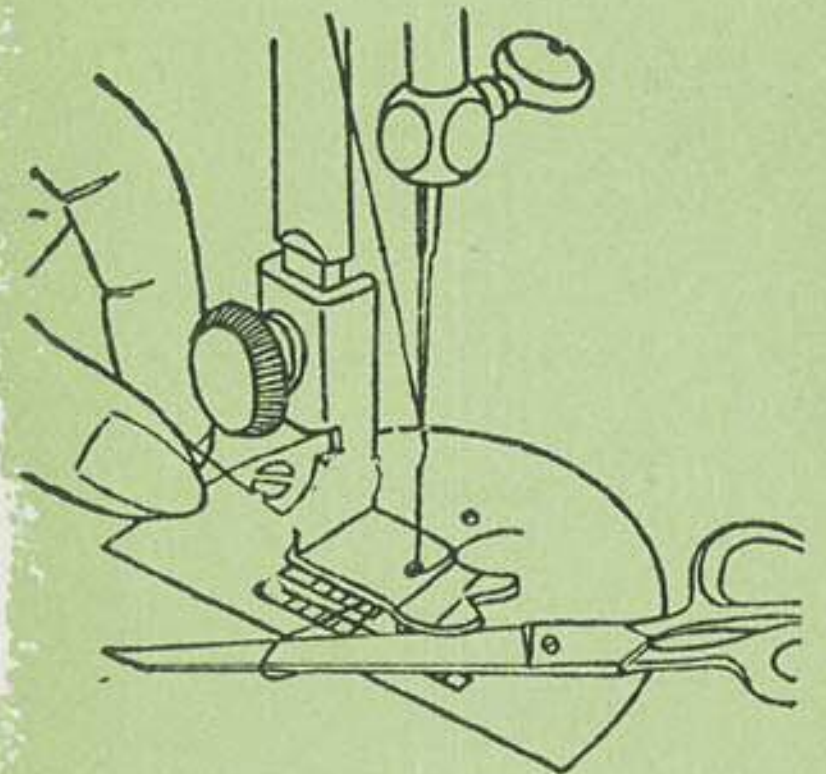
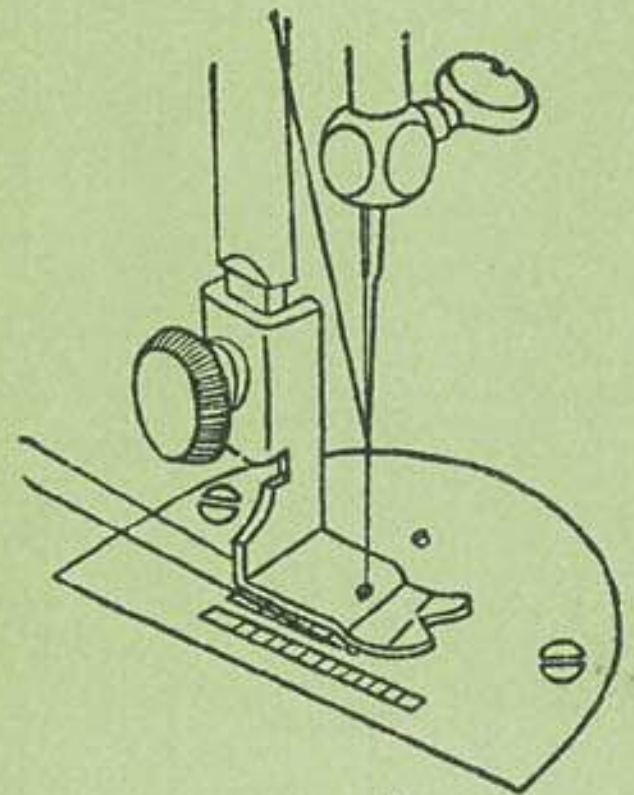



going to use for your finished article. This enables you to obtain the effect you wish.

And do be careful about the materials you use. The Ruffler works beautifully on such fabrics as organdy, gingham and net, but it won't ruffle a heavy fabric, such as denim. A stiff, glazed material should be run through the ruffler with the machine unthreaded before actually ruffling it, in order to soften the fabric. The binder functions nicely on light or medium weight materials but is unable to bind thick ones. The gathering foot does its best work on soft light or medium weight fabrics.

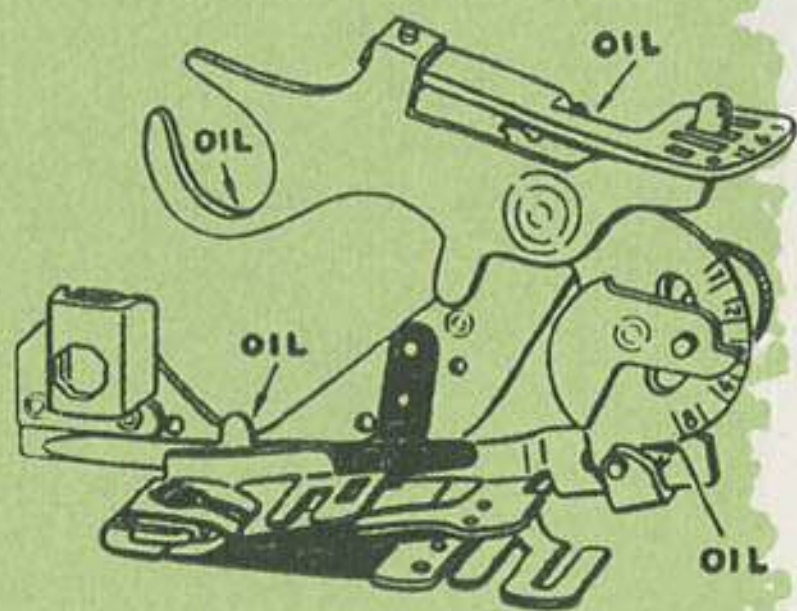

Of course you will take good care of your attachments. Sometimes they become bent and do not function properly. An occasional drop of oil or bit of petroleum jelly will help the movable parts of the attachments to work easily.

The Cloth Guide

Do you find it difficult to stitch in a straight line? Almost everyone does. However, your troubles will be over as soon as you use a Cloth Guide.

Before attaching the Cloth Guide, decide which of the screw holes in the bed of your machine you wish to use. If the stitches are to be placed less than $\frac{1}{2}$ inch from the edge, use the hole nearest the needle, but if they are to be made more than $\frac{1}{2}$ inch, use the hole farthest from the needle.

With the flat, vertical edge toward the needle, place the slot over the screw hole. Be sure that the flat edge is parallel to the edge of the presser foot. Adjust the Cloth Guide so that it is the desired distance from the needle. When it is in the correct position, turn the screw to fasten it securely.

Keep the edge of the fabric against the side of the guide as you stitch. You will find it very helpful when stitching staylines, seams, deep tucks, and wide straight hems. Once you have started to use a Cloth Guide, you will never want to sew without it.

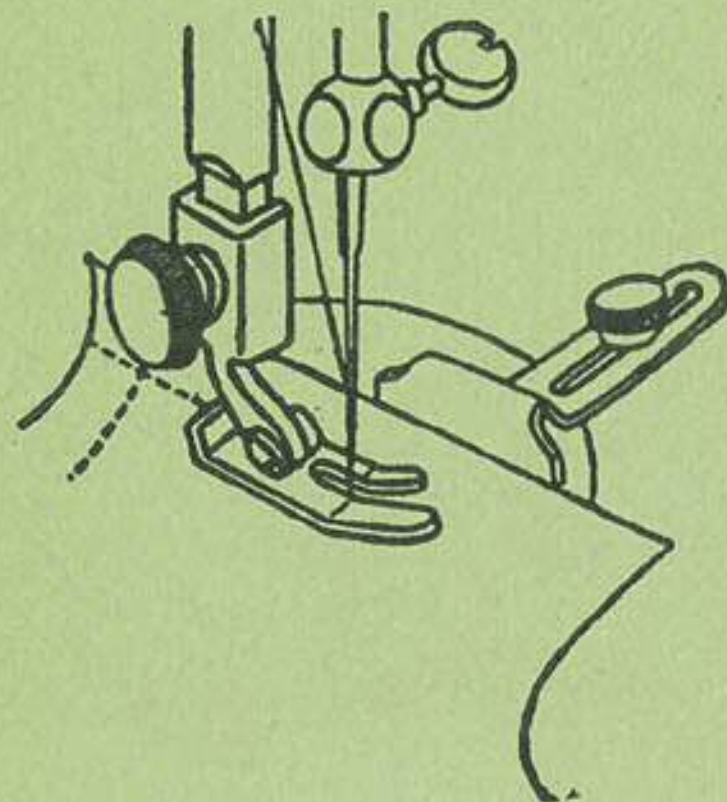
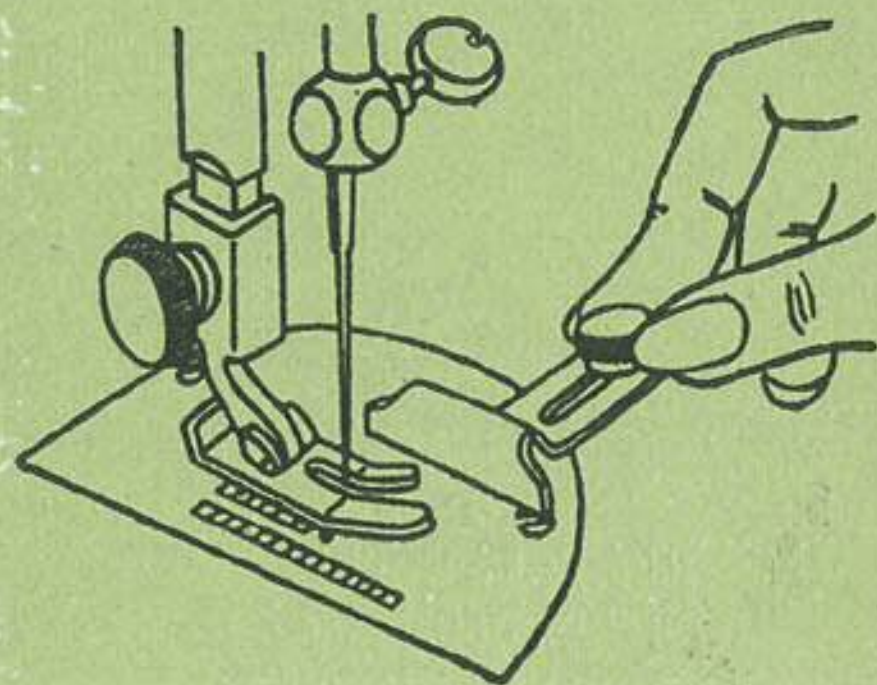

The Attachment Foot

In order to attach the Binder, Edgestitcher, and the Hemmers to your machine, it is necessary to remove the regular presser foot and replace it with a small Attachment Foot. If you look at your Attachment Foot, you will notice that there is a large screw on the back of it with a clamping head that extends to the front. When this screw is pressed forward against the back of the attachment foot, a space appears between the attachment foot and the end of the clamping head. This space is large enough to enable you to slip the new attachment in place.

After the Attachment Foot has been put on the machine, press the screw forward and slip the large hole in the Binder, Edgestitcher, or Hemmers over the clamping head. Slide the attachment to the left as far as possible and tighten screw so that the attachment is held firmly in place. The slot in each attachment enables you to move it from left to right so that you can stitch close to an edge or away from it. To do this, just loosen the screw at the back, move the attachment the desired distance, and tighten screw.

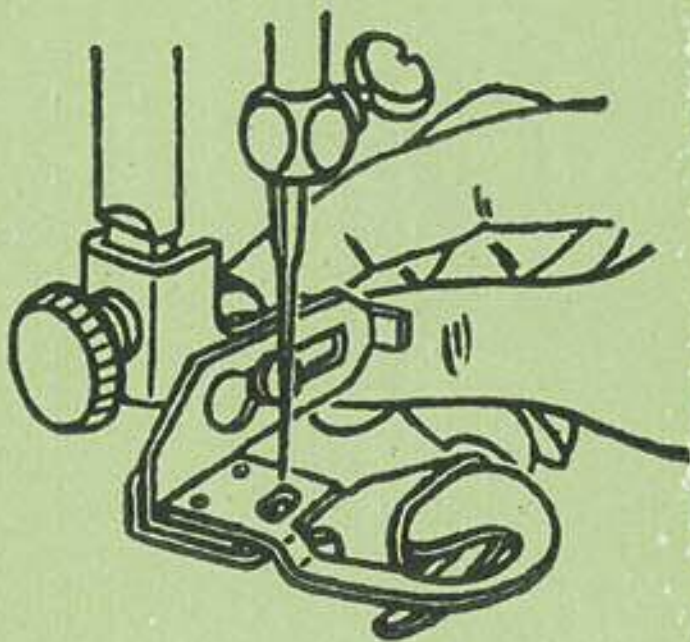
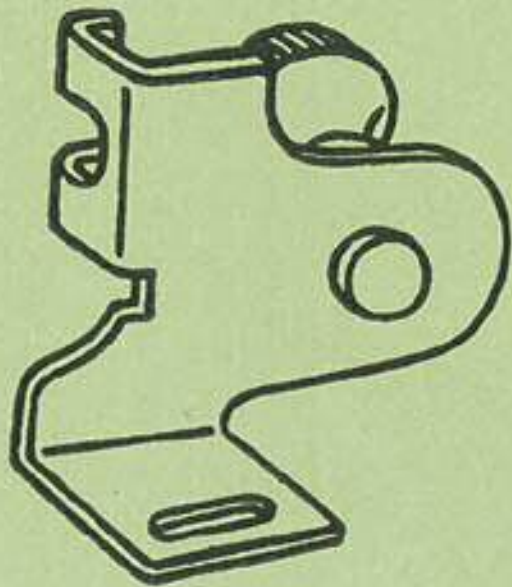

The Adjustable Zipper and Cording Foot

This attachment is both versatile and adjustable. It allows you to insert a zipper and to cover cord with ease. Because of the adjustable feature, you are able to stitch to the left or right of the zipper or cord without turning the material. It also allows the needle to enter the fabric close to the metal part of the zipper without danger of damaging it, and close to the cord without sewing through it.

After you have removed the presser foot from the machine, slip the Zipper and Cording Foot in place. Remember the needle should be at its highest point for this operation. Tighten the thumb screw so that the foot is held securely.

In order to move the foot from right to left, loosen the screw on the horizontal bar. Move the foot from side to side so that the needle can enter the slot on the left or the right.

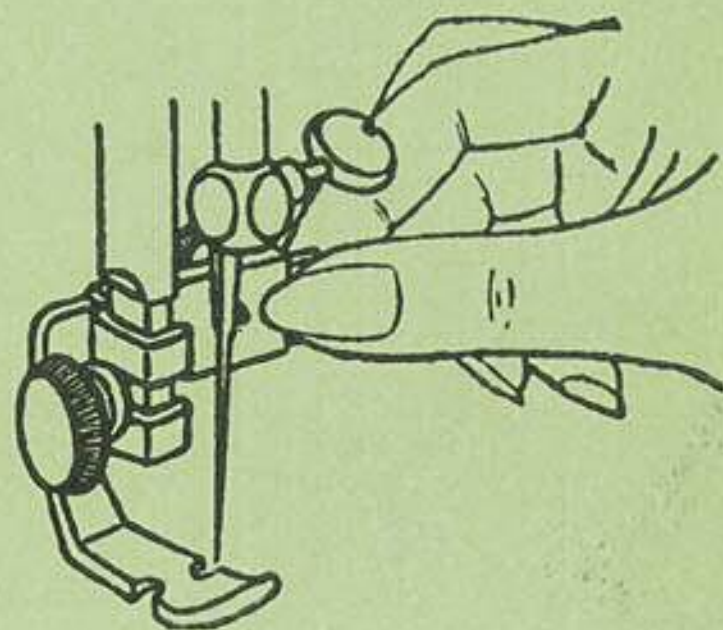

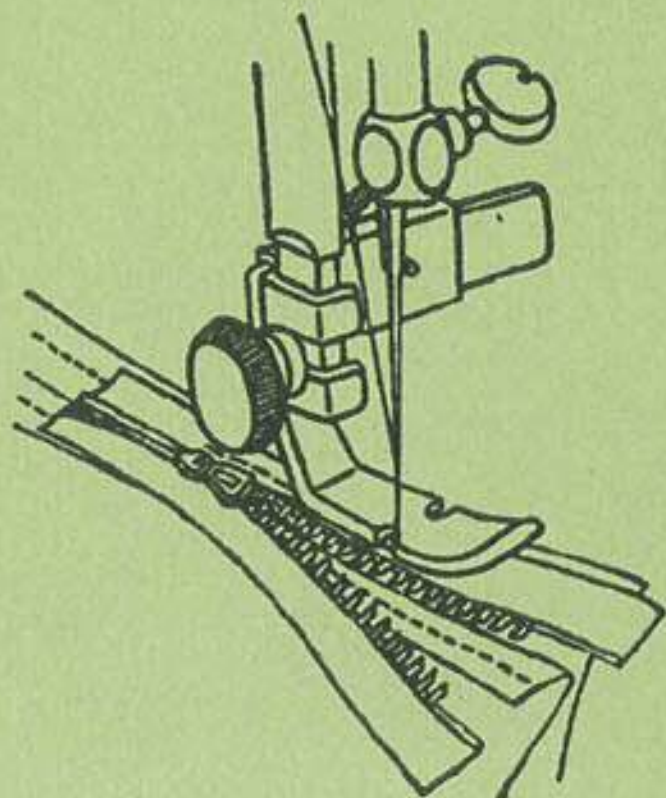

If you wish to stitch along the left side of the zipper, adjust the foot so that it is to the left of the needle with the needle passing through the opening on the right side of the foot, but if you want to stitch on the right side of the slide fastener, the foot should be placed to the right of the needle so that the needle passes through the opening on the left of the foot.

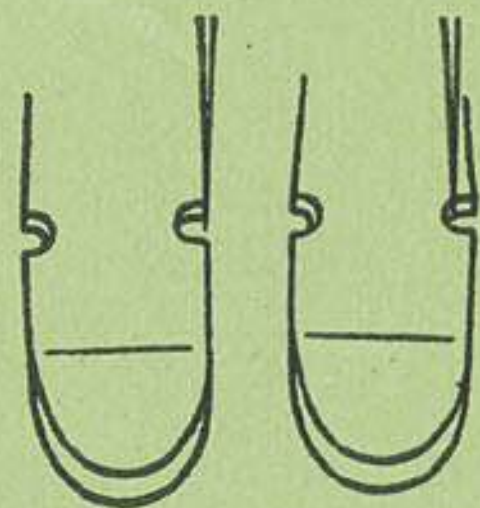

When you are using this foot to make cording or welting, you will probably find it easier to stitch to the left of the bulky area. To do this, the needle should pass through the opening on the right of the foot. If you wish to stitch a little bit away from the cord, set the foot so that the needle falls well into the circle of the hole, but if you want the stitching to be placed close to the cord, adjust the foot so that the needle enters the opening near the outside edge. Usually, you stitch away from the cord when you are making welting that is to be applied to another article so that this line of

stitching can be covered when the cording is enclosed.

To make the welting, cover the cord with a strip of true bias. Place it under the Adjustable Zipper and Cording Foot. Lower the needle and the foot. Guide the work by placing the second finger of the left hand close to the foot and the cord. This allows the first finger to ride along the cord. Use the right hand to hold the bias covered cord.

To enclose the welting, adjust the foot so that you can stitch to the right of the cord. Also adjust the foot so that the needle enters the opening on the left of the foot close to the outside edge.

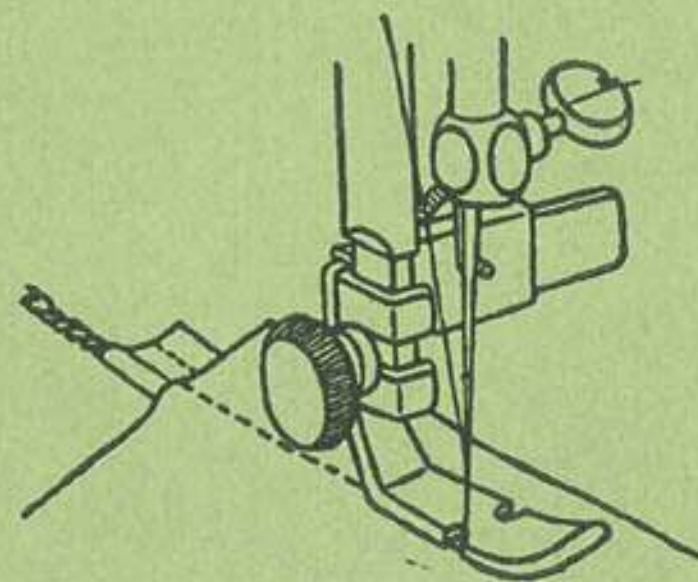
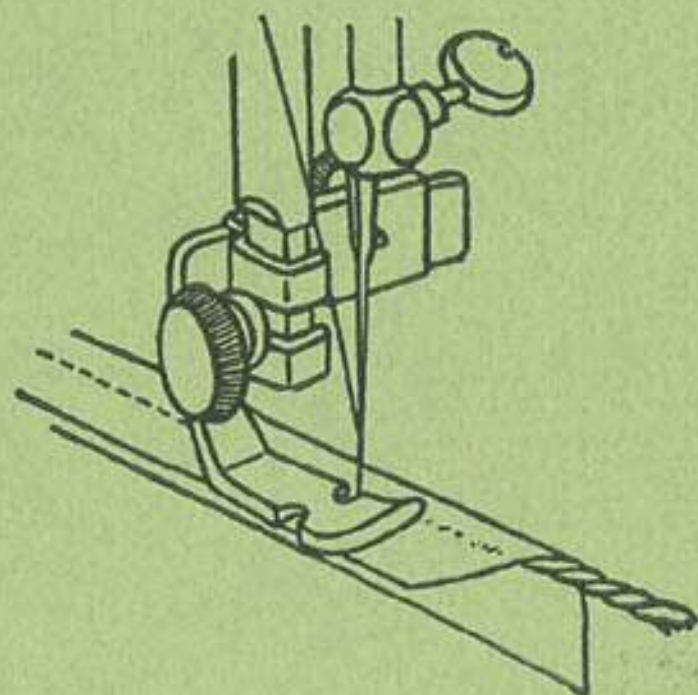

The Gathering Foot

As you know, gathering can be a tedious task when done by hand. Not only does it take considerable time to do, but it is also difficult to distribute the fullness evenly. However, when the Gathering Foot is used, these problems are eliminated. The gathers are made easily and quickly, and the fullness is stitched evenly in place.

After you have removed the regular presser foot, bring the bobbin thread to the upper part of the machine. Then attach the Gathering Foot, and place the upper and bobbin threads together under the foot.

Before beginning to stitch, certain adjustments should be made to the machine. Both the length of the stitch and the tension determine the fullness of the gathers. For slight fullness, set the stitch regulator for regular sewing and tighten the tension. However, for more fullness, the stitch should be lengthened. Remember that the longer your stitch is, the greater the fullness will be. Be sure to test the gathering on a scrap of the fabric

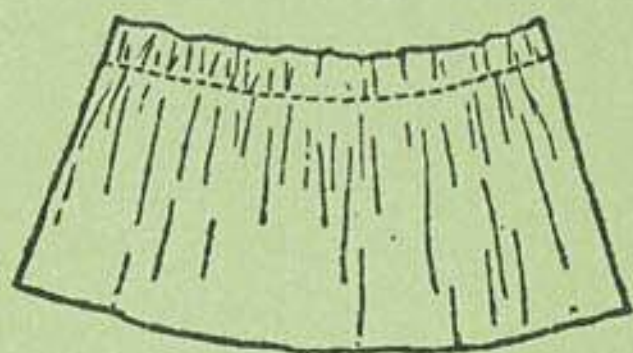
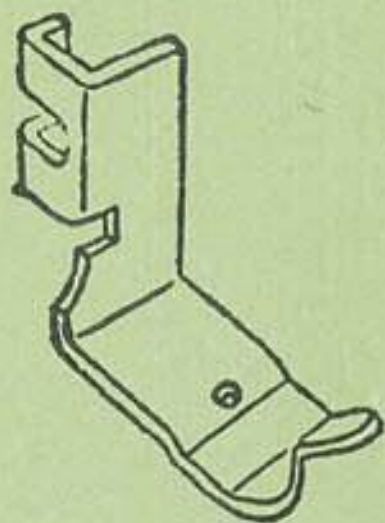

which you are going to use for the finished article. This enables you to see exactly how the finished row of gathering will look. In case you need to change the amount of fullness, you can easily do it.

At times, you may wish to make several rows of gathering to form shirring. If you do, use the Quilter Guide so that the lines of stitching will be evenly spaced. Attach the guide to the machine in back of the Gathering Foot by loosening the thumb screw and slipping it between the foot and screw. Tighten the screw securely. Set the guiding prong so that it follows the previous row of stitching.

As you stitch the various rows, you will notice that the fullness from the previous row seems to form tiny folds in the path of the needle. In order for each row to be evenly gathered, try to ease out this fullness as you stitch. You don't want to stitch in little folds of fabric which will mar the prettiness of the gathers.

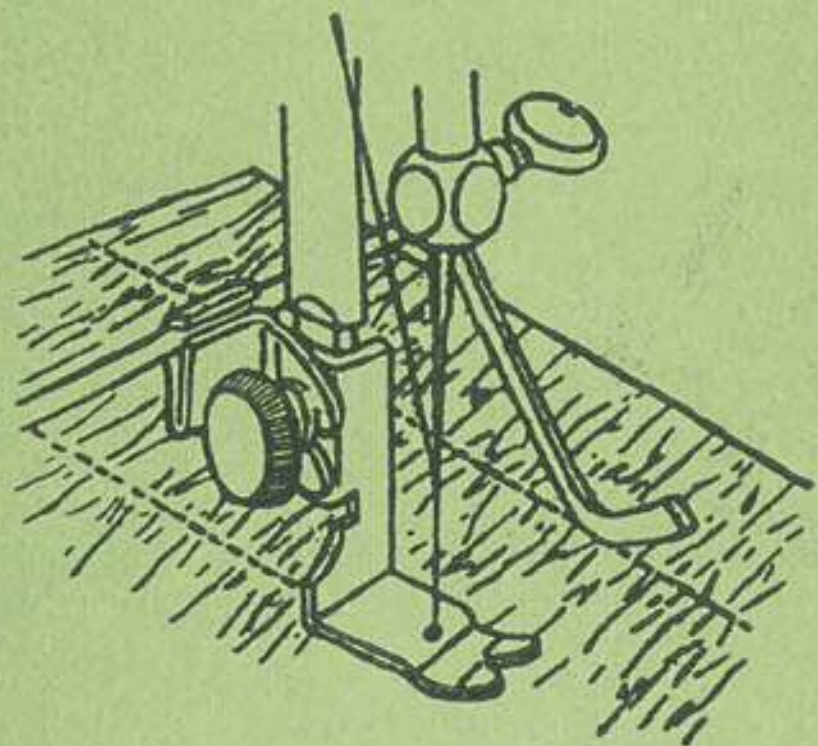

The Quilter

Although you can buy quilted material, you can't always purchase it in the color and texture you wish. At such times, you should remember that you can quilt it yourself by using the Quilter on your machine.

The Quilter is actually a guide, consisting of a curved prong attached to a long bar which runs through a forked holder. The prong may be shifted back and forth in the holder as well as up and down. This allows you to place the rows of stitching the desired distance apart.

Before attaching the Quilter, remove the regular presser foot and replace it with the Attachment Foot. Then loosen the thumb screw slightly, so that you can slip the forked holder between the thumb screw and foot. Draw it toward you from the back of the machine. When it is in place, turn the thumb screw to fasten it securely.

Before beginning to sew, adjust the length of the machine stitch. A long stitch will create the prettiest effect.

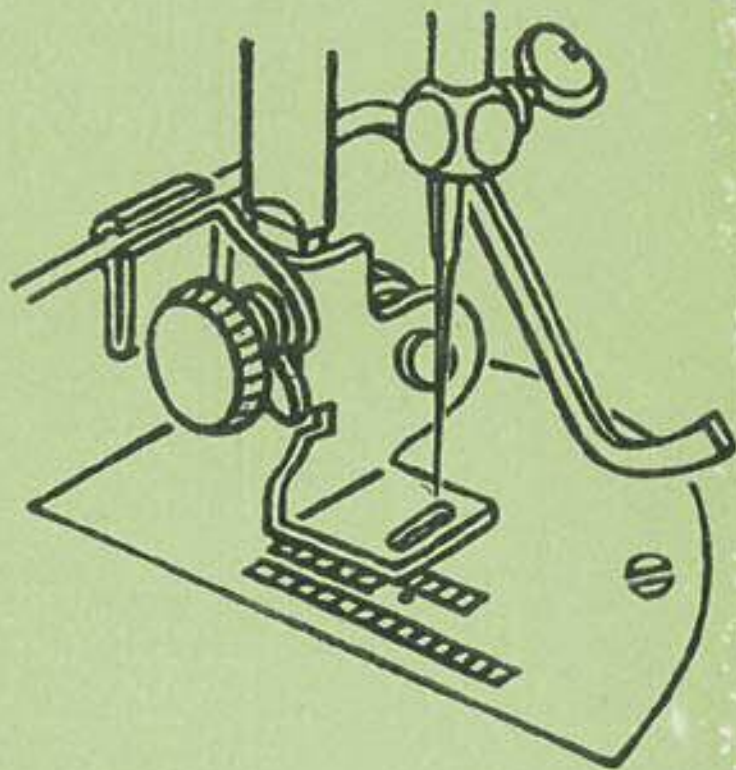
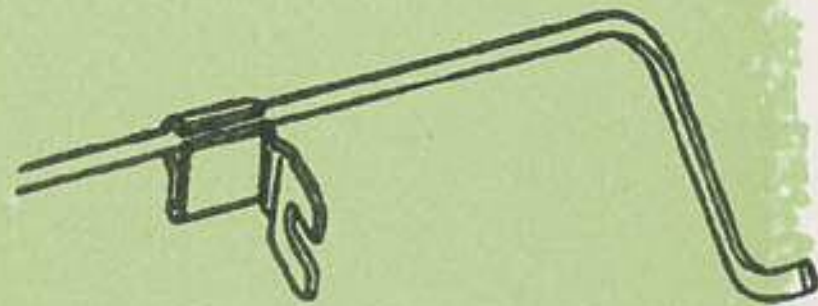

Of course you realize that the puffy look is obtained by stitching through several thicknesses of fabric. Two thicknesses of outing flannel or layers of wadding can be used under a layer of satin or some other pretty material. When wadding is employed, the layers of wadding are placed on the wrong side of the satin, and then covered with cheesecloth. The cheesecloth forms the wrong side of the material to be quilted.

As a guide for the first row of stitching, draw a line on the wrong side of your prepared material. Of course you know that you always work with the wrong side of the material up. After completing the first row of stitching, place the guiding prong on this stitched line so that the second row will be placed the desired distance from the first. Continue in this manner until the cloth is covered with rows of stitching. Then turn the material and stitch in the opposite direction so that your stitching forms a pattern of squares or diamonds.

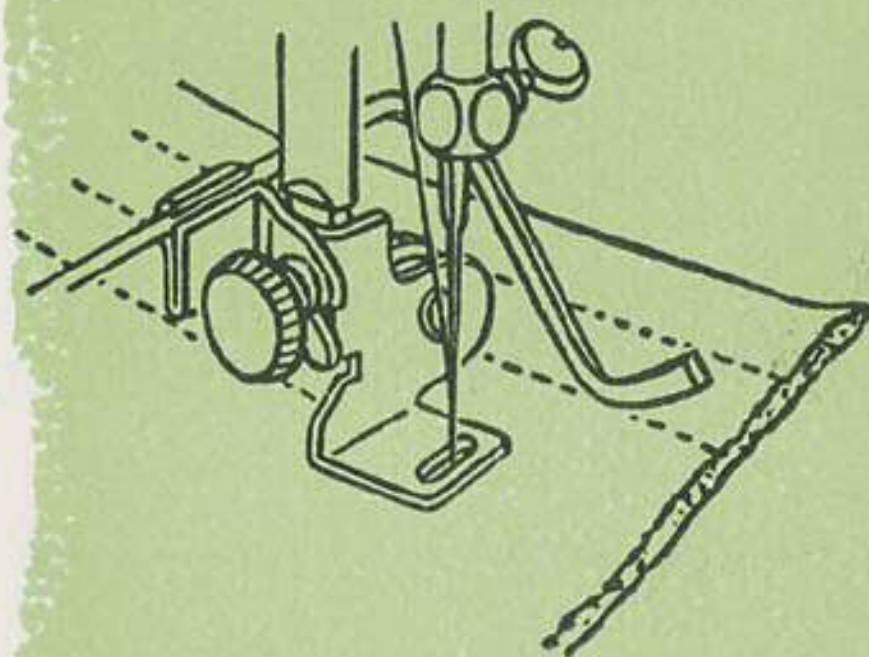

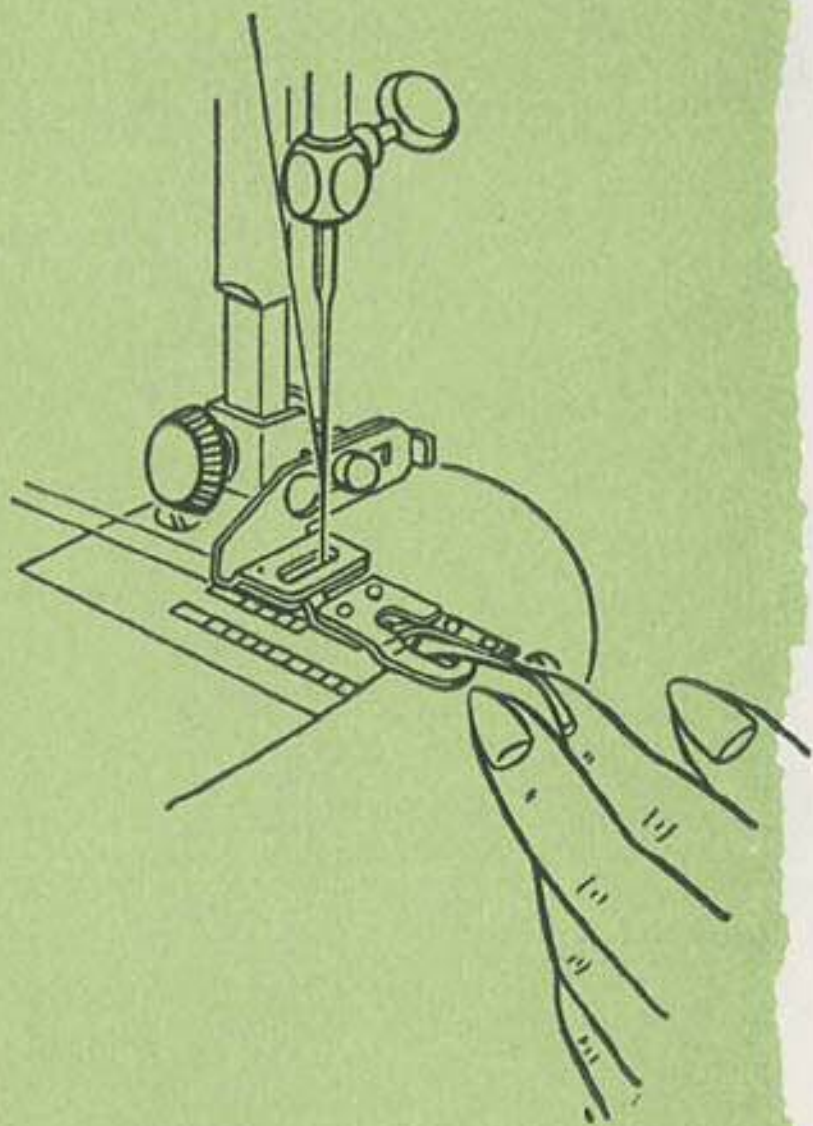
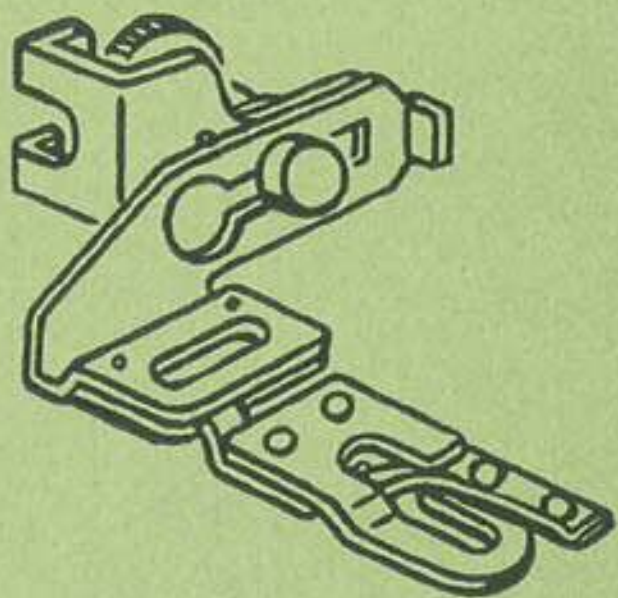

The Adjustable Narrow Hemmer

This attachment will enable you to turn a tiny hem and stitch it, all in one operation. And the nicest feature of it is that it is adjustable so that you can get your stitching very close to the turned edge, merely by moving the position of the narrow hemmer on the attachment foot.

After the regular presser foot has been removed from your sewing machine, replace it with the attachment foot. Then press the clamping screw in back of the attachment foot toward you and slip the narrow hemmer in place. See page 6 for detailed instructions on the use of the attachment foot. Then thread the machine correctly and place both threads under the narrow hemmer and directly in back of it to prevent tangling of threads.

Before beginning to stitch, be sure that the edge of your cloth is straight. It is impossible to make an even hem along a crooked edge.

With these preparations made, you are ready to insert the material into the hemmer. Hold the fabric between the first and second fingers of the left hand. Put the corner of the cloth between the curved prong and the rolled upper section. Lift the cloth slightly and roll the edge just a little bit to the left so that the material enters the scroll at a slight angle. Gently push the fabric away from you until it appears just beyond the needle hole. It is important that the cloth be brought to this point so that the small teeth called the feed can carry the fabric backward.

When the cloth is in the proper position, lower the needle and the presser bar. Be sure that the threads are in back of your work. Stitch slowly so that you can have perfect control of your cloth. Retard the progress of the material slightly. However, be sure to do this with a light touch. If you don't you will stretch your fabric.

Examine the stitching. If it is not as close to the edge as you desire, loosen the clamp-

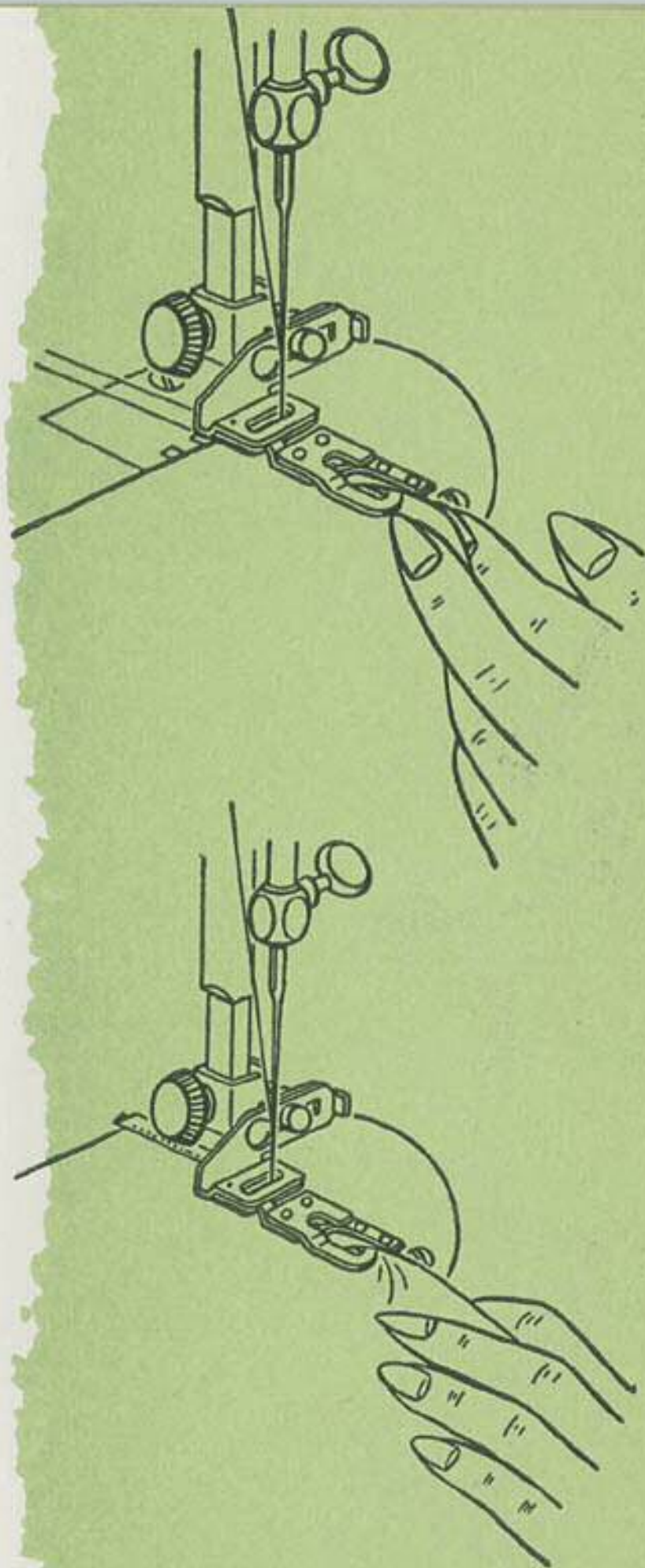

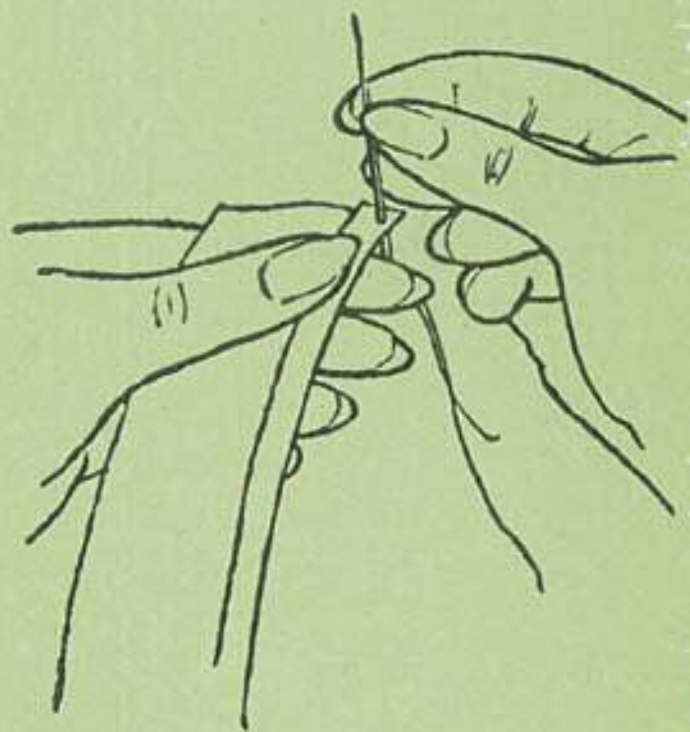
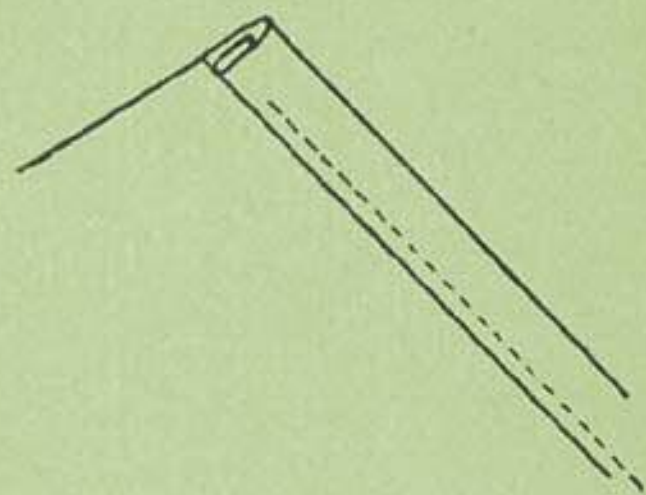

ing screw on the attachment foot and adjust the position of the narrow hemmer on it until the stitching is in the desired position.

The amount of cloth that you feed into the hemmer is most important. If you do not feed a wide enough fold into the hemmer, the raw edges will not be folded under, and if you feed too much into the hemmer, extra folds will appear which of course spoil the beauty of the hem. Probably the easiest way to guide the cloth is to hold it between the first and second fingers so that it extends upward between them to the depth of about $\frac{5}{8}$ inch when the fingers are placed about 1 inch in front of the hemmer.

If you examine the hem, you will notice that the stitching begins about $\frac{5}{8}$ inch from the edge. Usually, this unstitched portion becomes part of a seam. However, if you wish to start the stitching exactly at the edge, fold the fabric into a $\frac{1}{8}$ inch hem for about 2 inches. Through this tiny hem, pass a threaded needle to catch the folds. When you insert the cloth into the hemmer, hold the ends of the thread with the right hand

and pull the threads straight back, carrying the material through the hemmer until the edge of the fabric hem is directly under the needle hole. As you begin to stitch, continue to hold the threads. Pull them gently as you take the first few stitches. When the edge of the cloth reaches the end of the hemmer, and you are sure that the feed will carry the cloth backward, you can let go of the threads.

When you are able to make a perfect hem with ease, try trimming it with lace or rick rack. The fabric is inserted in the hemmer in the same manner. The edge of the lace or rick rack is placed in the U-shaped slot which is in front of the needle. As you stitch, hold the lace up slightly with the right hand so that you can watch the stitching of the hem. Keep the lace snug against the inside edge of the slot. If you don't, it will not be sewed to the material.

Please note: — If puckering occurs when hemming light weight fabrics, place a piece of scotch tape over the needle hole.

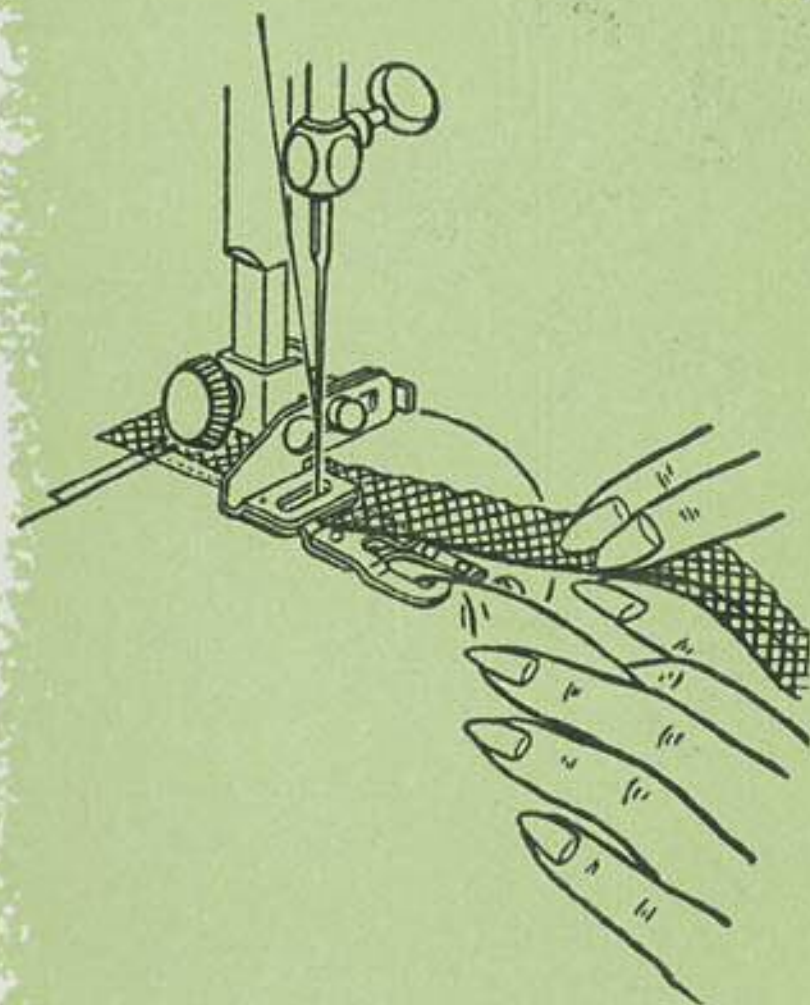
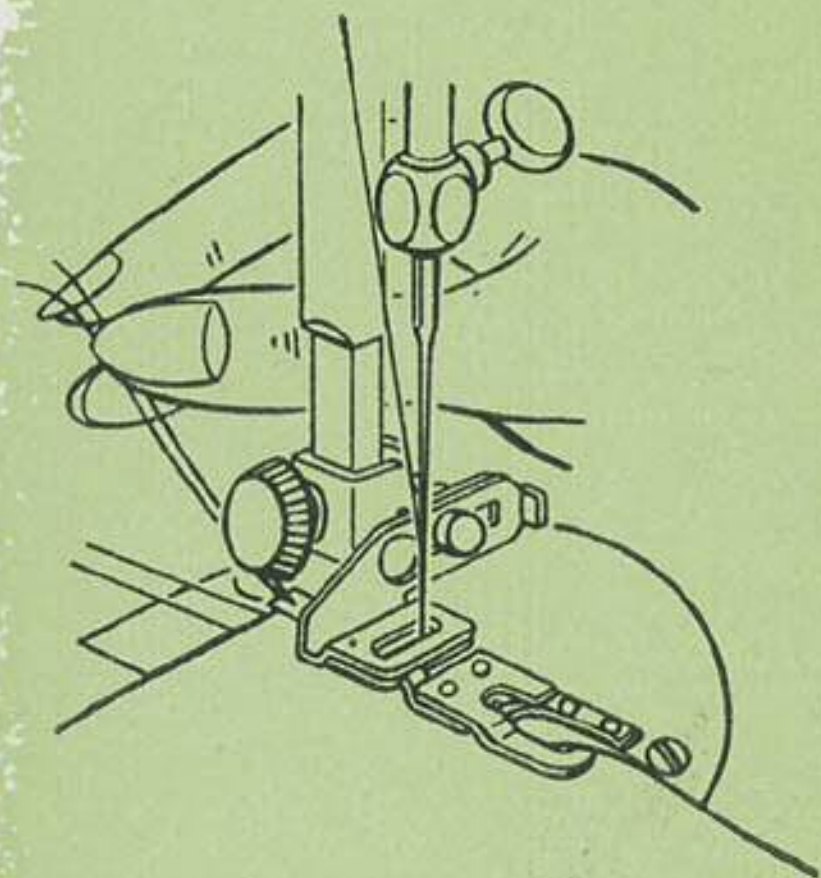

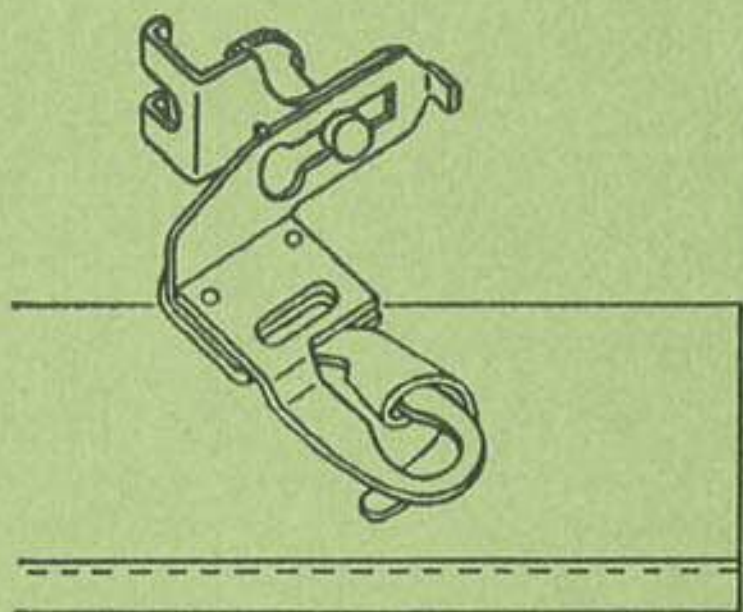

The Hemmer ($\frac{1}{4}$ inch hem)

No doubt you find the making of a $\frac{1}{4}$ inch hem a troublesome task. To measure, crease, pin, and baste a narrow hem takes time and patience. However, when this Hemmer is used, all of these operations are done automatically.

After the regular presser foot has been removed and replaced with the attachment foot, the hemmer can be slipped into place. Then the threads are put under and in back of the attachment. The fabric is inserted between the narrow, horizontal band and the rounded prong, and then twisted up and over the rounded prong, and finally allowed to curl under it. If you examine your Hemmer, you will notice that the cloth follows the direction of the narrow band.

When you insert the cloth, hold it in both hands and draw the material back and forth a few times as you feed the cloth into the Hemmer so that the scroll is filled completely. Remember, the fabric has to fold under a portion of the rounded prong. If

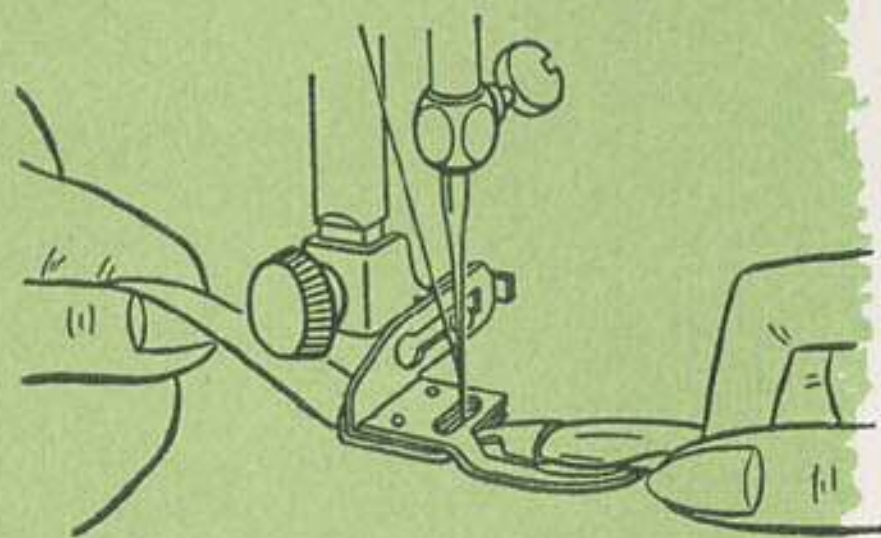

the cloth does not curl under easily, fold the raw edges of the material over $\frac{1}{8}$ inch for about 2 inches.

When the scroll is filled, draw the cloth into position so that the stitching will start close to the end. Then lower the presser bar and begin to stitch. Guide the material gently so that the scroll remains filled. Place the left hand lightly on the cloth, retarding its progress slightly. If too little material is fed into the Hemmer, the raw edges of the fabric will not be turned under, and if too much is allowed to enter the scroll, an uneven hem will result.

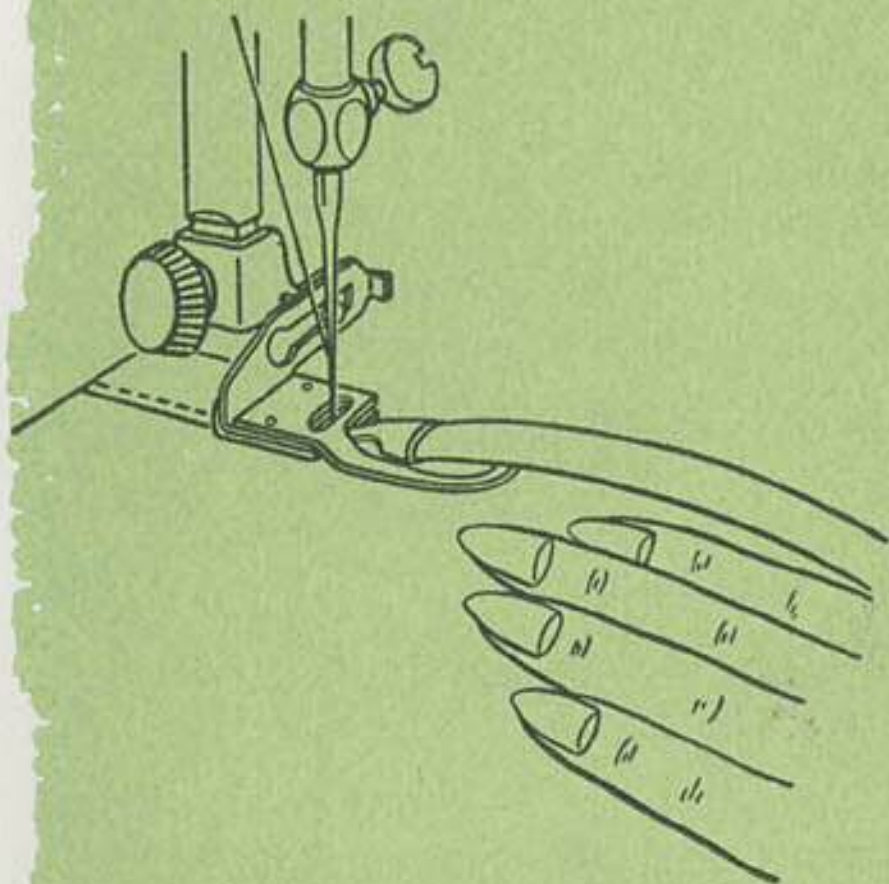

The Edgestitcher

Dainty lace insertions, perky embroidered edges, and delicate pipings can add a simple, but pretty, decorative touch to a plain article. However, it often requires a considerable amount of skill to produce a professional look. Fortunately, there is an attachment that will help you to join rows of lace, to insert lace between two pieces of fabric, to trim a finished edge with lace or embroidery, as well as with a fine line of piping. By using the Edgestitcher, you can perform these processes with ease and delicacy.

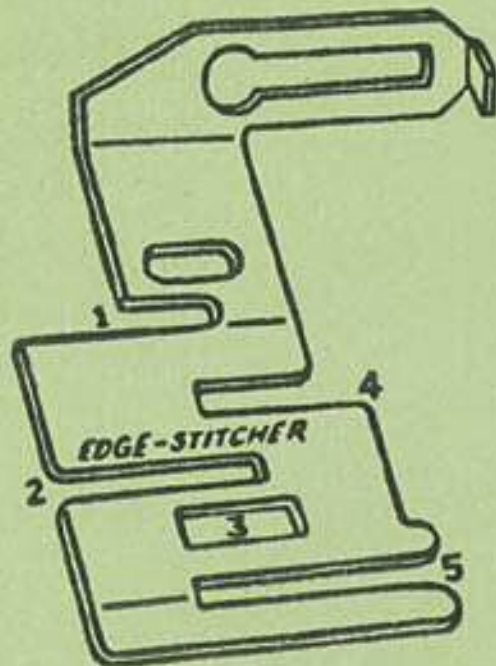

As you will notice, there are several slots in your Edgestitcher. These openings serve as guides in sewing together the various pieces of material. In order to help you, they have been numbered in the accompanying drawing. For instance, if you want to sew lace edging to a finished edge of fabric, the piece of material that will be on top will be placed in slot 1, and the under one in slot 4.

After the regular presser foot has been removed, and replaced by the Attachment Foot, the Edgestitcher is fastened to the foot. The threads are put under and in back of the attachment. The various materials are placed in the correct slots and drawn under the needle and back of the Edgestitcher, so that the feed will carry them backwards as you stitch. Then lower the needle and the presser bar.

As you stitch, hold the material that is in the left-hand slot in your left hand and that in the right-hand slot in your right hand, so that the materials overlap just a little bit. Although the overlap is small, it makes it possible for you to keep the edges, which are stitched together, snugly against the interior of the guiding slot.

If you wish to sew lace to a folded edge, you must first turn under the fabric $\frac{1}{4}$ inch and crease it in place. Put the folded edge in slot 1 with the right side up and the lace in slot 4.

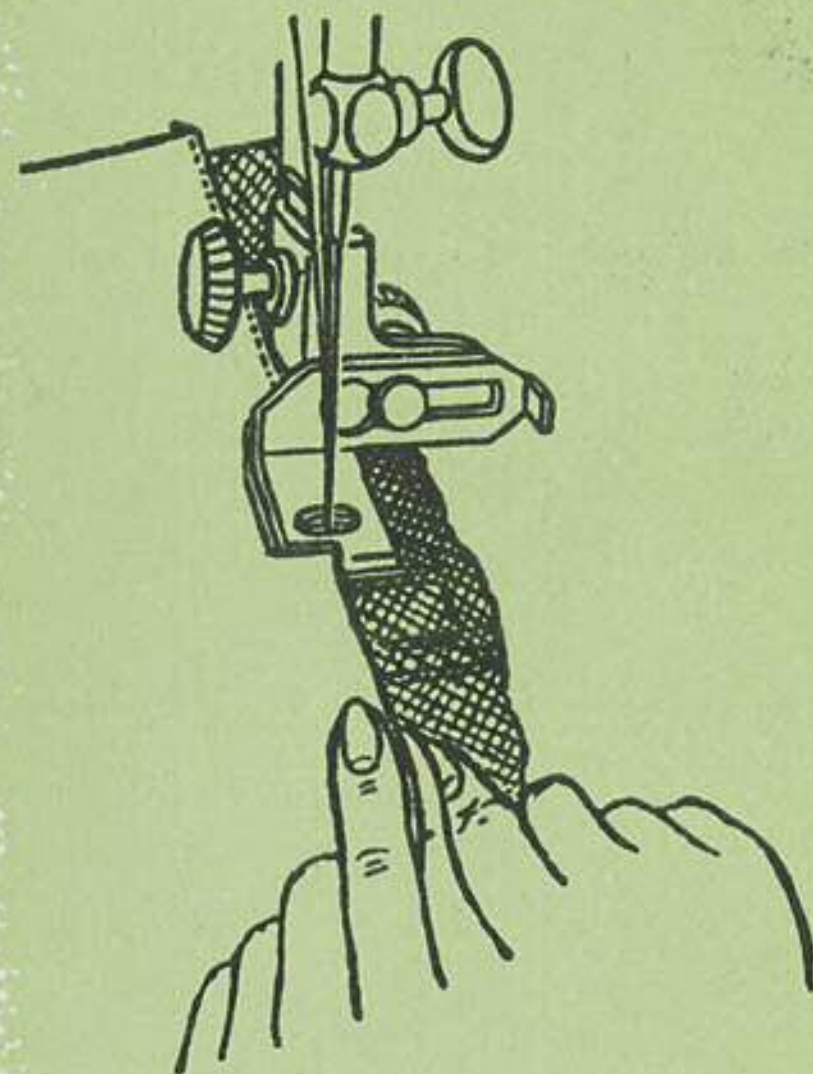

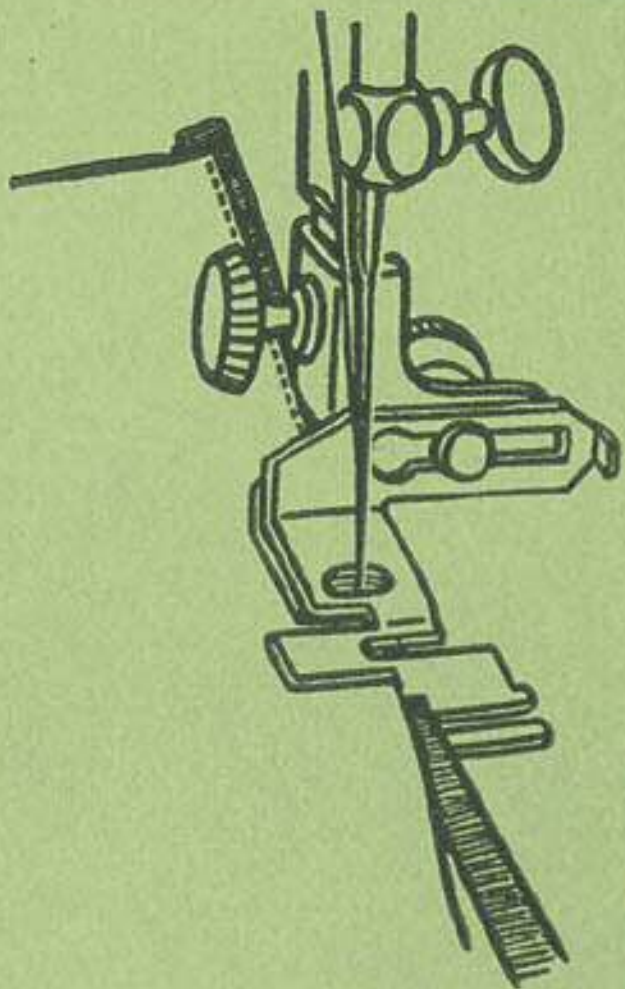

When using a piping to trim an article, the piping is put in slot 3. For a wide piping, the fabric is placed in slot 4 and the fold of the piping is to the left of slot 3. However, for a narrow piping, the fabric is placed in slot 2 and the folded edge of the piping is to the right in slot 3. Slot 5 is used as a guide when stitching a French seam.

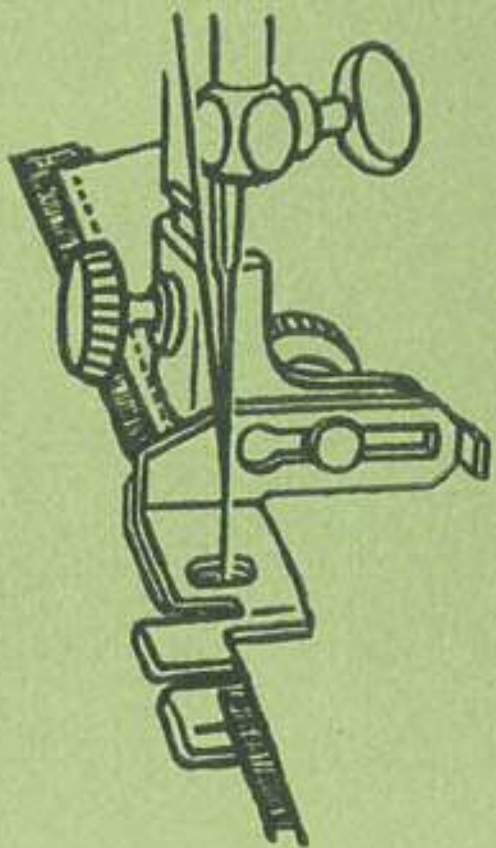

The Binder

This clever device allows you to finish an edge with bias binding. Not only can you use commercial bias binding, but also binding which you cut yourself. In one operation both edges of the binding are stitched neatly and evenly in place. Pinning and basting are eliminated. Raw edges disappear forever. The stitching is even and close to the folded edge of the binding.

If you examine your Binder, you will notice that there is a cone-shaped scroll which has several small slots in graduated sizes. These slots are arranged to hold various sizes of commercial single fold binding, ranging from the smallest size 1 to the largest size 5. The largest slot which holds number 5 bias tape will be the one which you will use most often.

This cone-shaped scroll is also divided by a slot. It is used when inserting a bias strip which you have cut yourself so that it enters the interior sections of the scroll.

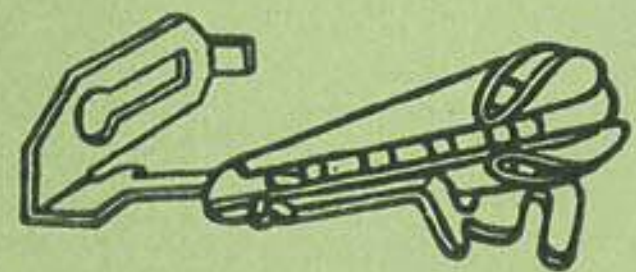
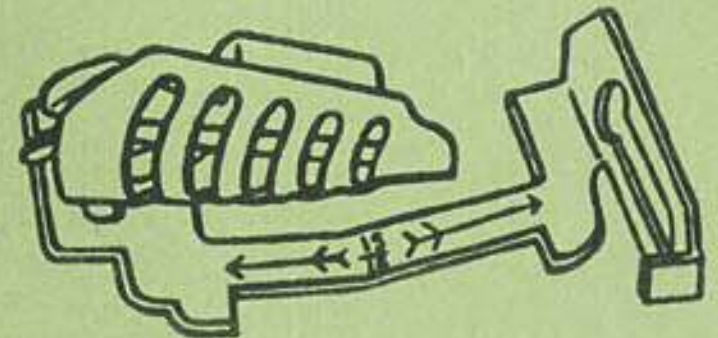
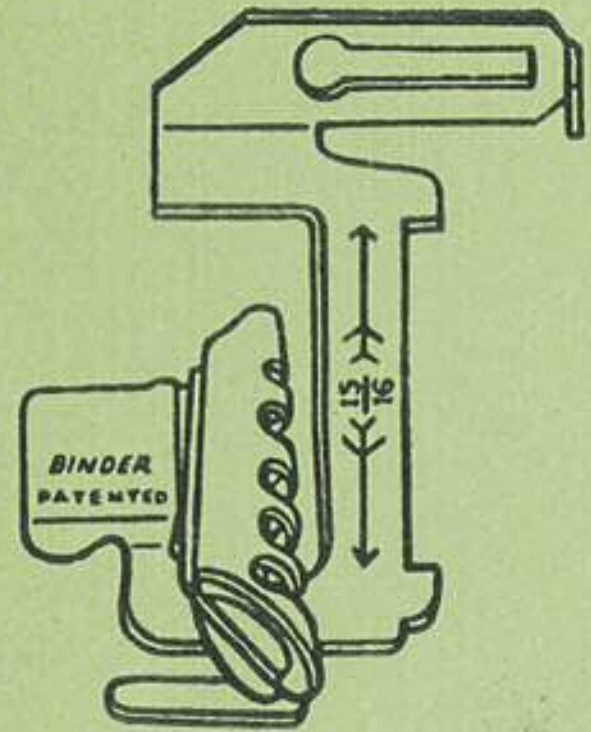



After the regular presser foot has been removed, replace it with the Attachment Foot. Then fasten the Binder to the foot. If you are using commercial single fold binding, cut the end to a long, thin point so that it can be drawn easily through the correct slot. Insert this pointed binding into the top outside slot. After inserting the point of the binding in the slot, use your stiletto to push the binding gently toward the needle.

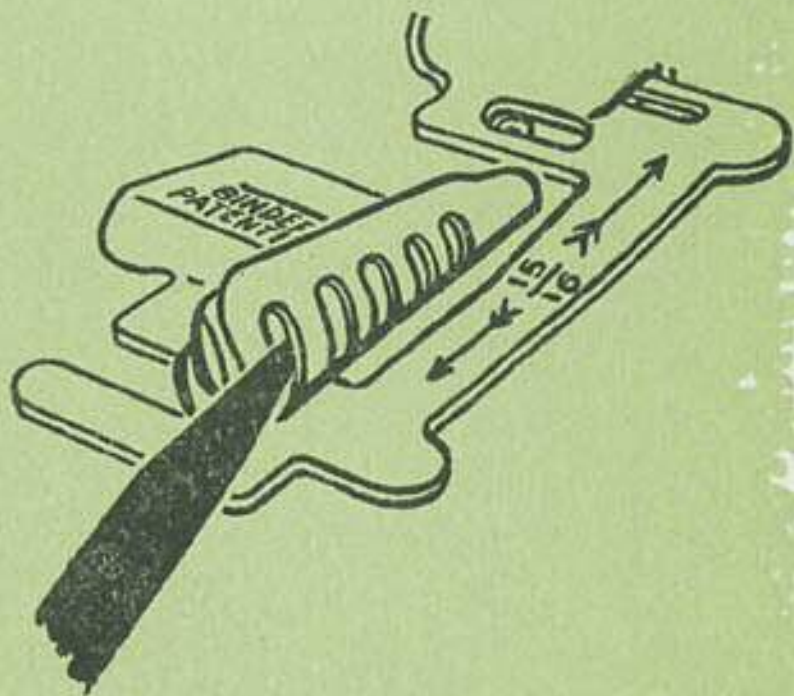

When the binding emerges from the scroll, draw it under the needle hole and over the feed. Lower the needle and presser bar. Stitch several inches to see if the stitching is the desired distance from the edge. If it isn't adjust the position of the Binder.

Place the material to be bound in the center section of the scroll. Draw it backward under the needle hole. It is important that the material being bound is always well into the Binder at a point close to the needle. If you put the second finger of your left hand on the fabric near the needle and

allow it to rest on the square flat portion of the Binder, you can easily keep the material in this position.

In case you wish to use a bias strip which you have cut yourself, remember to cut the material $\frac{15}{16}$ inch wide if it does not stretch, and 1 to $1\frac{1}{4}$ inches wide if it does stretch. The gauge on the right hand side of the Binder will help you measure $\frac{15}{16}$ inch strip. And of course, you will be careful to cut it on the true bias.

When the strip has been correctly cut, clip the end to a point. Fold the binding in half with the wrong sides together and place it in the center slot which divides the scroll in half. Pull the bias backwards so that it falls into the inside of the scroll. Draw the binding under the needle hole. Take a few stitches to check the position of the stitches. Notice how the raw edges are folded under. When you are satisfied with the position of the stitches, begin to stitch. Guide the fabric as you did for commercial binding, close to the needle.

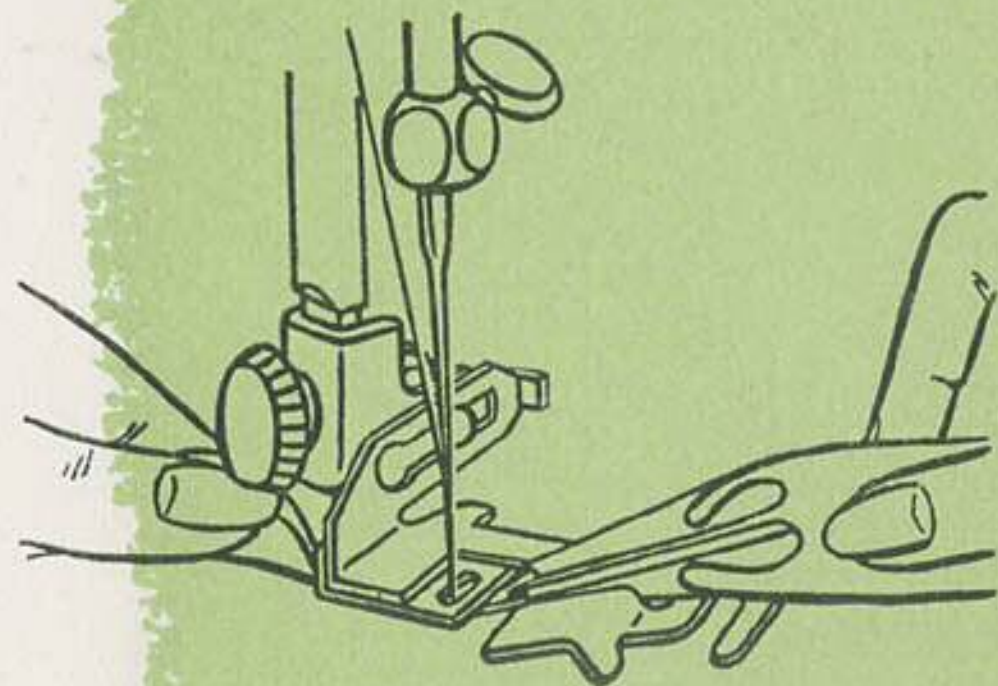
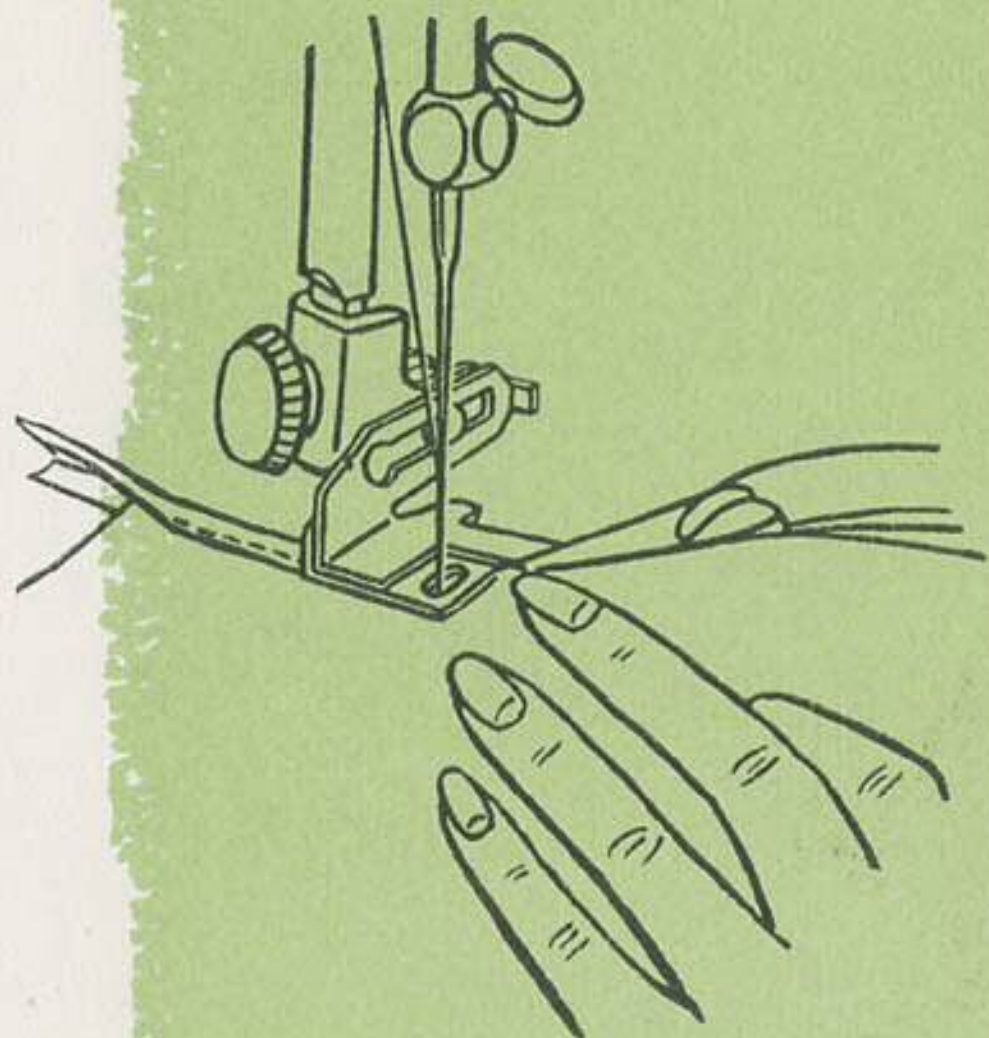

The Ruffler

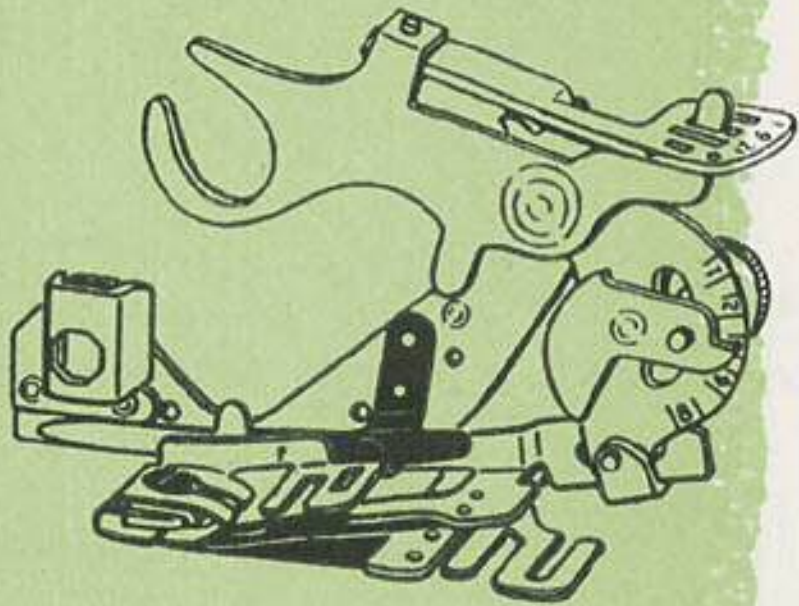

This ruffler has been set at the factory to sew on your sewing machine. However, because of differences in machines, and to allow you to get the best possible work from Your Ruffler, it may be necessary to adjust it to your machine. See page 30 for easy instructions on how to do this.

Before fastening the Ruffler to the machine, examine it carefully. Notice the two blades. The lower one is connected to a horizontal bar which has three slots. These slots are seam guides. The second blade has a saw-tooth edge at one end. When it is moved forward, the tiny teeth catch the fabric, forcing the material forward into gathers or pleats.

Above the blade is the needle hole and near it are two slots. The open one is used to guide material which is being stitched to the ruffle, whereas the enclosed one is used as a guide for a piping strip.

Proceeding upward in your observation you will find a claw-like end which you can move up and down. This part, called the fork

arm, is placed astride the needle clamp. As the needle bar goes up and down, so does the fork arm which in turn forces the ruffling blade to move backward and forward.

You will notice that there are two parts which are marked with numbers. The upper one or lever is connected to the fork arm and has four little slots — marked 1, 6, 12, and with a star. If you lift up this part, you will notice that it can be moved to right or left so that the projector can be slipped into a different slot.

When the projector is in slot 1, the fabric will be gathered or pleated at every stitch. When it is in the slot marked 6, a pleat will be made every 6 stitches; in the slot marked 12, a pleat every 12 stitches. However, when you do not wish to gather or pleat the material, the projector should be under the slot marked with a star.

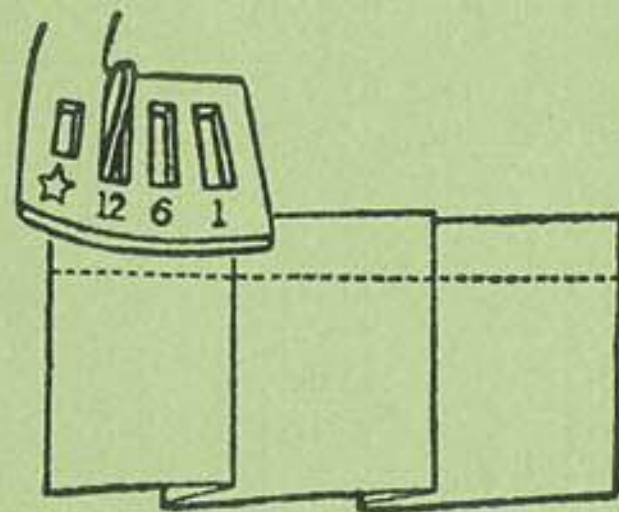
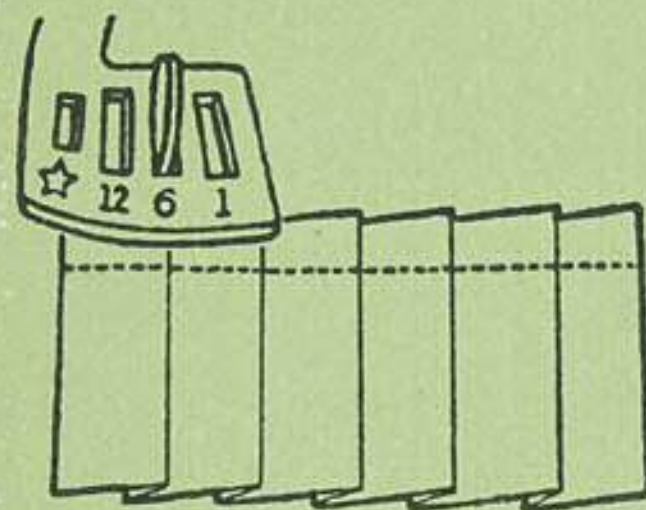
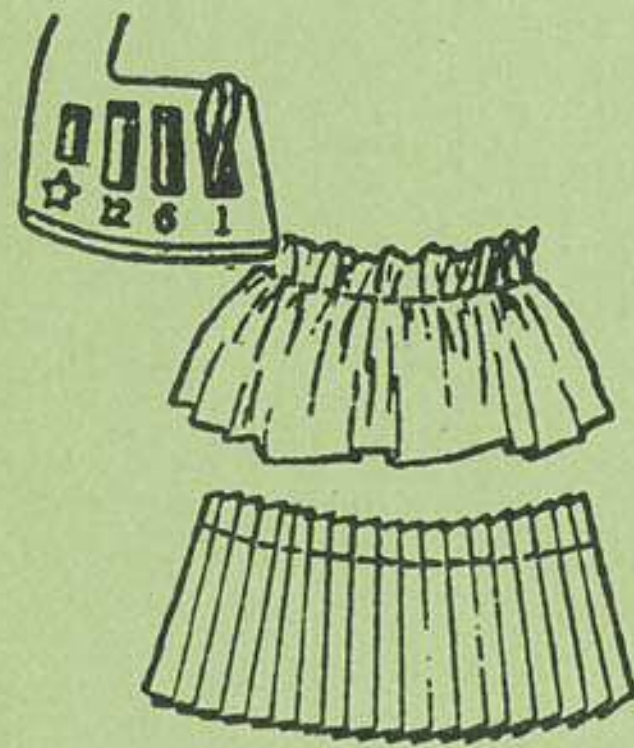
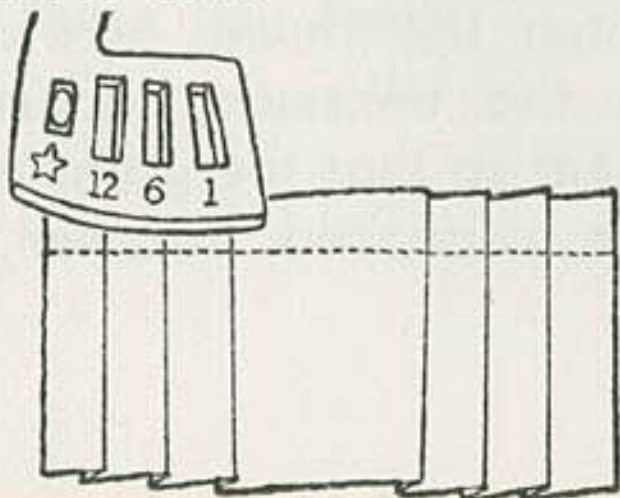

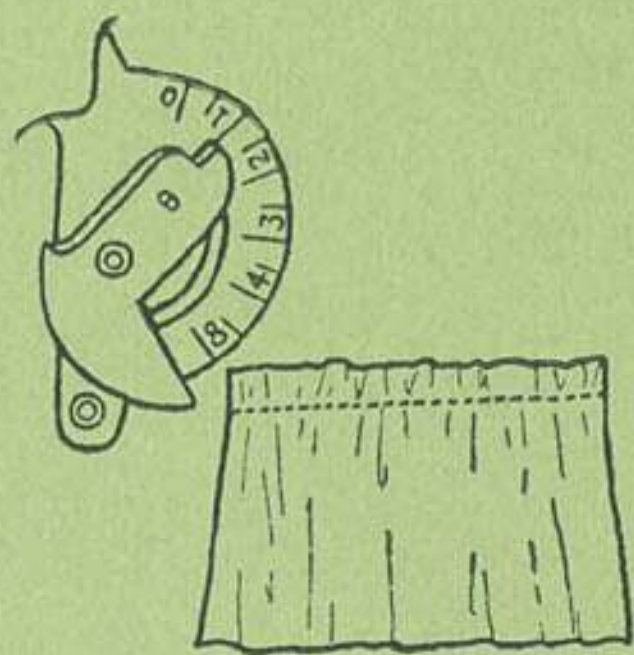

Below the projector is the other marked part or dial gauge. It is used to indicate the fullness of gathers or width of pleat. When the pointer is all the way up past 1, there should be no gathers. Move the pointer downward and gathering should take place between 1 and 3. Adjust to suit fullness desired; higher numbers provide more fullness, lower numbers, less. A deep pleat is obtained by setting at 8. Shallower pleats are made at the lower numbers. Loosen the knurled screw when adjusting, but be sure it is firmly tightened while using the Ruffler.

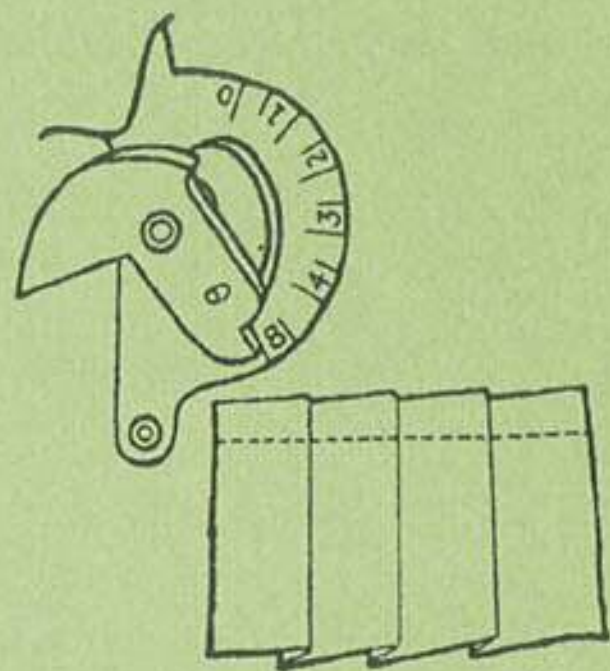

Attaching Ruffler to Machine

After the regular presser foot has been removed, attach the Ruffler to the presser bar with the fork arm astride the needle clamp. Tighten the thumb screw securely. Then make the necessary adjustments to the attachment so that the gathers or pleats will be made as desired. In order to be sure

that the amount of fullness or the size of the pleat is exactly right, test the adjustments you have made on a scrap of the material that you are going to use for the finished article.

It is also well to remember that the length of your machine stitch will influence the fullness of your ruffle and the distance between the pleats. A small stitch will give more fullness than a large one and the space between the pleats will be smaller.

The material to be ruffled should be slipped between the two blue blades and under the prong that separates the seam guides. Put the fabric snugly against the end of the seam guide and draw it gently backward under the needle hole and the attachment so that it covers the feed. Never draw the fabric toward you. If you do, you will break those tiny teeth.

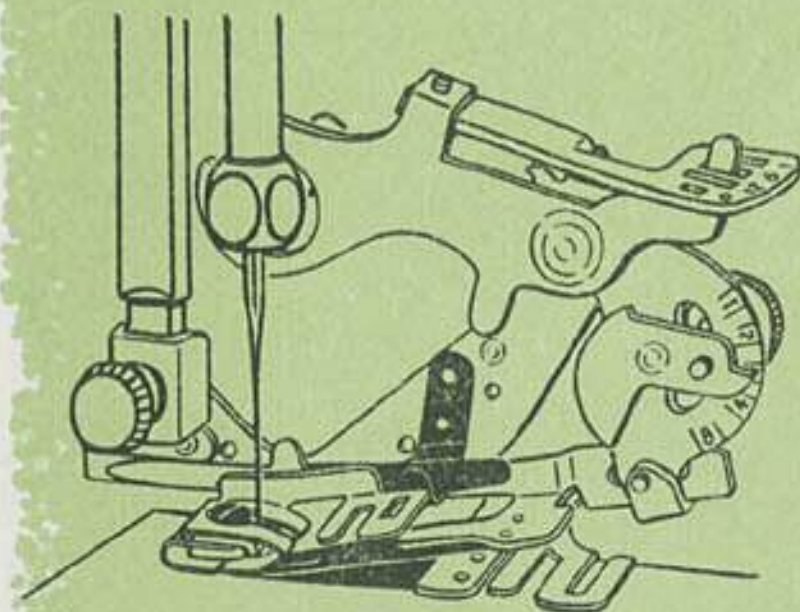
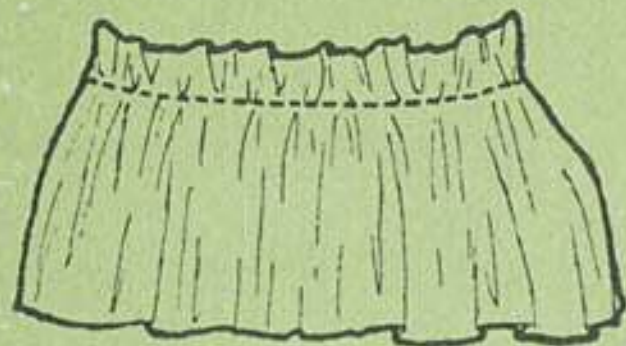
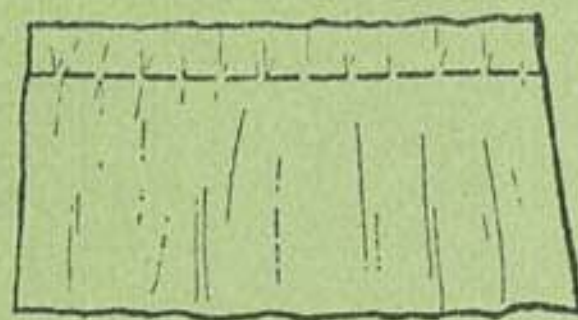

When the material is in position, lower the needle and presser bar, and begin to stitch. Keep the speed of your machine at an even rate so that the fullness of the ruffle does not vary. Fluctuations in speed will influence the appearance of your ruffle.

Testing and Adjusting Ruffler to Machine

Oil ruffler at points shown under "Helpful Suggestions" first. Then, after you have fastened the ruffler to your sewing machine, set the projector in the slot marked 6. Put the pointer at number 8 on the dial gauge. Set your machine for a medium stitch. Now check the ruffler by sewing a narrow strip of scrap fabric. If all of the pleats are stitched down, your ruffler is adjusted properly and is ready to use.

If some of the pleats are not sewed down, loosen the locking screw on the right front side of the ruffler and move it toward the end marked "+". Refasten screw securely and check stitching again. You may need to experiment a few times before the ruffler is adjusted to sew down the pleats.

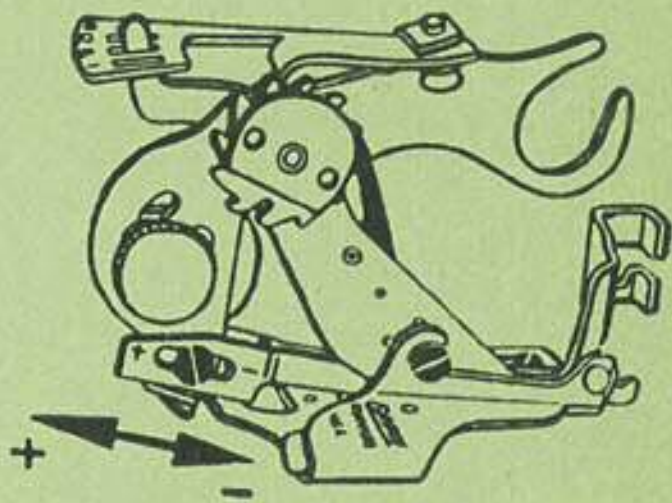

1004